

LIST OF VALID AIP SUPPLEMENTS

NUMBER	FIR/AERODROME (LOCATION) STATE	SUBJECT
13/26	Douglas Charles (TDPD)	Change in Aerodrome Operating Hours
12/26	Trinidad and Tobago (TTPP, TTCP)	Establishment of Restricted Areas for Unmanned Aircraft System (UAS) in Trinidad and Tobago
11/26	Terrance B. Lettsome (TUPJ)	Procedures for VFR Flights
10/26	Argyle (TVSA)	Aerodrome and Air Traffic Services (ATS) Hours of Service
09/26	Robert L. Bradshaw (TKPK)	AVGAS Availability
07/26	St. Vincent and the Grenadines	Aerodrome Hours of Service Amended for J.F. Mitchell Airport (TVSB), Canouan Airport (TVSC) and Union Island Airport (TVSU)
06/26	A.N.R. Robinson (TTCP)	Pavement Strength Amended
04/26	John A. Osborne (TRPG)	Twilight Limitations at John A. Osborne Airport
03/26	John A. Osborne (TRPG)	Aerodrome Chart – ICAO and Aerodrome Obstacle Chart – ICAO Type A – Operating Limitations at John A. Osborne Airport
02/26	John A. Osborne (TRPG)	Aerodrome Meteorological Warnings Not Available
01/26	Terrance B. Lettsome (TUPJ)	Aerodrome Obstacles at Terrance B. Lettsome International Airport
47/25	Terrance B. Lettsome (TUPJ)	Restrictions for Use of British Virgin Islands Airspace
46/25	British Virgin Islands	Aerodrome Meteorological Warnings Not Available
45/25	Antigua and Barbuda	Air Navigation Services Charges Amended
44/25	Oil Nut Bay Heliport (TUON)	Aerodrome Data Updated
43/25	V.C. Bird (TAPA)	Aerodrome Data Updated
42/25	Douglas Charles (TDPD)	NDB 'DOM' 273.0kHz Unserviceable
41/25	Douglas Charles (TDPD)	PAPI Operating Light Intensity RWY 27 at Douglas Charles International Airport

NUMBER	FIR/AERODROME (LOCATION) STATE	SUBJECT
40/25	Canefield (TDCF)	Surface Wind Speed and Direction Indicators Unserviceable at Canefield International Airport
39/25	Canefield (TDCF)	Fuel Prior Permission Required at Canefield International Airport
38/25	Douglas Charles (TDPD)	Charges for Operations Outside Normal Aerodrome Hours at Douglas Charles International Airport
37/25	A.N.R. Robinson (TTCP)	Aerodrome Obstacles at A.N.R. Robinson International Airport
36/25	Terrance B. Lettsome (TUPJ)	Update to Aerodrome/Heliport Chart and Aircraft Parking Docking Chart for Terrance B. Lettsome International Airport (TUPJ)
35/25	Maurice Bishop (TGPY)	NDB 'GND' Decommissioned
34/25	Piarco FIR (TTZP)	Suggested Routings to be Utilized Within the Piarco FIR due to the Removal of the UA550, UA551 and UA561 Routes
32/25	Lauriston (TGPZ)	Amendment to Approach and Runway Lighting for RWY 09 at Lauriston Airport (TGPZ)
29/25	Terrance B. Lettsome (TUPJ)	Amendments to Procedures for VFR Flights
28/25	Piarco (TTPP)	NDB 'TRI' Unserviceable
27/25	Piarco FIR (TTZP)	Change in Airport Name
26/25	John A. Osborne (TRPG)	Air Traffic Services (ATS) Limitations
25/25	Piarco (TTPP)	Pavement Strength Amended
24/25	Canefield (TDCF)	Pavement Strength Amended
22/25	Coco Point Lodge Airport (TAPT)	Change in Airport Name
21/25	Auguste George (TUPA)	Prior Permission Required at Auguste George International Airport (TUPA)
19/25	Barbuda International Airport (TAPB)	Aerodrome Data Updated
18/25	Barbuda International Airport (TAPB)	Amendments to Air Navigation Obstacles
17/25	Piarco FIR (TTZP)	Amendments to A555 Route
16/25	Robert L. Bradshaw (TKPK)	Search and Rescue Services
15/25	C.J. Lloyd (TQPF)	Rescue and Fire Fighting Services
14/25	Maurice Bishop (TGPY)	Search and Rescue Services

NUMBER	FIR/AERODROME (LOCATION) STATE	SUBJECT
13/25	British Virgin Islands	Safety Reporting for Auguste George (TUPA), Terrance B. Lettsome International Airport (TUPJ) and Virgin Gorda Airport (TUPW)
12/25	Terrance B. Lettsome (TUPJ)	Ground Handling Services Requirement
11/25	Terrance B. Lettsome (TUPJ)	Amendments to the Phraseology of the Departure Instructions at the Terrance B. Lettsome International Airport
09/25	Robert L. Bradshaw (TKPK)	Airspace Classification Amended
07/25	John A. Osborne (TRPG)	Airport Restriction at John A. Osborne International Airport
06/25	Piarco (TTPP) and A.N.R. Robinson (TTCP)	Inclusion of Aerodrome Obstacles
04/25	V.C. Bird (TAPA)	Meteorological Services Amended
03/25	Douglas Charles (TDPD)	Vertical Limits of the Air Traffic Services Airspace and Airspace Classification Amended
02/25	Canefield (TDCF)	Vertical Limits of the Air Traffic Services Airspace and Airspace Classification Amended
29/24	C.J. Lloyd (TQPF)	Amendments to the Aerodrome data for the C.J. Lloyd International Airport (TQPF)
27/24	V.C. Bird (TAPA)	Establishment of Area Chart – ICAO V.C. Bird TMA
26/24	Piarco (TTPP) and A.N.R. Robinson (TTCP)	TTPP RNAV (GNSS) RWY 10, TTPP RNAV (GNSS) RWY 28, TTCP RNAV (GNSS) RWY 11 and TTCP RNAV (GNSS) RWY 29 Charts
24/24	Piarco (TTPP)	Model Aircraft Display
19/24	Douglas Charles (TDPD)	Extension of RWY 09/27 at the Douglas Charles Airport
15/24	Piarco FIR (TTZP)	Establishment of Waypoint CAIRN on the Common Boundary between the Pointe-a-Pitre (Guadeloupe) Terminal Control Area (TMA) and the Piarco Flight Information Region (TTZP)
14/24	St. Vincent and the Grenadines (TVSA, TVSB, TVSC, and TVSU)	Airport Service Charge

LIST LAST UPDATED 02 April 2026

**PIARCO INTERNATIONAL NOTAM OFFICE****AIP
SUPPLEMENT**

Tele: 1 868 669-4128
1 868 668-8222 ext 2510
FAX: 1 868 669 1716
AFTN: TTPPYNYX
Email:aimpublication@caa.gov.tt

TRINIDAD & TOBAGO
CIVIL AVIATION AUTHORITY,
P.O. BOX 2163, NATIONAL MAIL CENTRE,
PIARCO
REPUBLIC OF TRINIDAD AND TOBAGO

13/26
01 APR 26

AD**13. DOUGLAS CHARLES INTERNATIONAL AIRPORT (TDPD)****CHANGE IN AERODROME OPERATING HOURS****Effective: 260401 to 270401**

Aerodrome operating hours are now 1000 UTC to 2359 UTC.

Prior notification is required for operations occurring after 0000 UTC.

For prior notification, please submit request to aim@daspa.dm or at telephone number:
1 767 255 9173

END

Intentionally left blank



PIARCO INTERNATIONAL NOTAM OFFICE

AIP SUPPLEMENT

Tele: 1 868 669-4128
1 868 668-8222 ext 2510
FAX: 1 868 669 1716
AFTN: TTPPYNYX
Email:aimpublication@caa.gov.tt

TRINIDAD & TOBAGO
CIVIL AVIATION AUTHORITY,
P.O. BOX 2163, NATIONAL MAIL CENTRE,
PIARCO
REPUBLIC OF TRINIDAD AND TOBAGO

12/26
24 MAR 26

ENR

12. TRINIDAD AND TOBAGO

Establishment of Restricted Areas for Unmanned Aircraft System (UAS) in Trinidad and Tobago

Effective: 260324to PERM

The restricted areas for Trinidad and Tobago are updated as follows:

In Eastern Caribbean AIP page ENR 5.1 PROHIBITED, RESTRICTED AND DANGER AREAS

6. Table of Prohibited Restricted and Danger Areas

- Update Row 3 subheading: **RESTRICTED AREAS** to **RESTRICTED AREAS (General Aviation)**.
- Add the following Restricted Areas (UAS) for Trinidad and Tobago:

Identification, name and lateral limits	Upper Limit Lower Limit	Remarks, (time of activity, type of restriction, nature of hazard, risk of interception)
1	2	3
RESTRICTED AREAS (UAS) TRINIDAD AND TOBAGO		
TTR1U - PORT OF SPAIN Area bounded by lines joining points 104056N/0613200W; 104056N/0613000W; 103834N/0613000W; 103834N/0613200W to the point of origin.	<u>2500FT</u> SFC	All UAS flights require prior authorization from the TTCAA, except those conducted for medical or national security operations.
TTR2U - POINT LISAS Area bounded by lines joining the points 102634N/0612833W; 102300N/0612708W; 102147N/0612817W; 102217N/0612934W; 102325N/0613016W; 102525N/0613035W; 102636N/0612949W to the point of origin.	<u>2500FT</u> SFC	All UAS flights require prior authorization from the TTCAA, except those conducted for medical or national security operations.
TTR3U- POINT-A-PIERRE Area bounded by lines joining the points 101936N/0612817W; 101928N/0612554W; 101831N/0612558W; 101834N/0612715W; 101822N/0612716W; 101827N/0612822W to the point of origin.	<u>2500FT</u> SFC	All UAS flights require prior authorization from the TTCAA, except those conducted for medical or national security operations.

Identification, name and lateral limits	Upper Limit Lower Limit	Remarks, (time of activity, type of restriction, nature of hazard, risk of interception)
1	2	3
<p>TTR4U - CARONI SWAMP</p> <p>Area bounded by lines joining the points 103837N/0612947W; 103837N/0612821W; 103813N/0612739W; 103740N/0612743W; 103703N/0612537W; 103502N/0612516W; 103303N/0612650W; 103106N/0612746W; 102936N/0612816W; 102955N/0612835W; 103057N/0612827W; 103139N/0612757W; 103255N/0612755W; 103626N/0612910W; 103719N/0612947W; 103719N/0613014W; 103820N/0613014W; 103820N/0612947W to the point of origin.</p>	<p><u>1000FT</u> SFC</p>	<p>All UAS flights require prior authorization from the TTCAA, except those conducted for medical or national security operations.</p>
<p>TTR5U - CHAGUARAMAS</p> <p>Area bounded by lines joining the points 104351N/0614042W; 104431N/0613650W; 103930N/0613558W; 103908N/0613820W; 104041N/0613838W; 104025N/0614007W to the point of origin.</p>	<p><u>2500FT</u> SFC</p>	<p>All UAS flights require prior authorization from the TTCAA, except those conducted for medical or national security operations.</p>
<p>TTR6U - GALEOTA</p> <p>Area bounded by lines joining the points 100928N/0610018W; 100935N/0605942W; 100830N/0605927W; 100833N/0605909W; 100813N/0605904W; 100759N/0610015W; 100829N/0610019W; 100831N/0610006W to the point of origin.</p>	<p><u>2500FT</u> SFC</p>	<p>All UAS flights require prior authorization from the TTCAA, except those conducted for medical or national security operations.</p>
<p>TTR7U - POINT FORTIN</p> <p>Area bounded by lines joining the points 101148N/0614137W; 101114N/0614109W; 101117N/0614053W; 101043N/0614045W; 101034N/0614121W; 101011N/0614148W; 101035N/0614208W; 101045N/0614155W; 101115N/0614219W to the point of origin.</p>	<p><u>2500FT</u> SFC</p>	<p>All UAS flights require prior authorization from the TTCAA, except those conducted for medical or national security operations.</p>
<p>TTR8U - LA BREA</p> <p>Area bounded by lines joining the points 101600N/0613741W; 101308N/0613638W; 101220N/0613735W; 101220N/0613824W; 101531N/0613835W to the point of origin.</p>	<p><u>2500FT</u> SFC</p>	<p>All UAS flights require prior authorization from the TTCAA, except those conducted for medical or national security operations.</p>
<p>TTR9U - CARRERA CONVICT PRISON</p> <p>Area bounded by lines joining the points 103944N/0613734W; 103952N/0613725W; 103942N/0613718W; 103936N/0613730W to the point of origin.</p>	<p><u>2500FT</u> SFC</p>	<p>All UAS flights require prior authorization from the TTCAA, except those conducted for medical or national security operations.</p>
<p>TTR10U - PRISON ESTATE AROUCA</p> <p>Area bounded by lines joining the points 103745N/0612029W; 103743N/0612007W; 103722N/0612008W; 103722N/0611952W; 103654N/0611952W; 103652N/0612014W; 103657N/0612036W to the point of origin.</p>	<p><u>2500FT</u> SFC</p>	<p>All UAS flights require prior authorization from the TTCAA, except those conducted for medical or national security operations.</p>

Identification, name and lateral limits	Upper Limit Lower Limit	Remarks, (time of activity, type of restriction, nature of hazard, risk of interception)
1	2	3
TTR11U - PORT OF SPAIN PRISON Area bounded by lines joining the points 103941N/0613200W;103942N/0613036W; 103938N/0613036W;103938N/0613039W to the point of origin.	<u>2500FT</u> SFC	All UAS flights require prior authorization from the TTCAA, except those conducted for medical or national security operations.
TTR12U - EASTERN CORRECTIONAL AND REHABILITATION CENTRE Area bounded by lines joining the points 103658N/0611531W; 103705N/0611523W; 103702N/0611521W; 103647N/0611522W; 103647N/0611531W to point of origin	<u>2500FT</u> SFC	All UAS flights require prior authorization from the TTCAA, except those conducted for medical or national security operations.
TTR13U - CLAXTON BAY CORRECTIONAL FACILITY Area bounded by lines joining the points 102201N/0612527W; 102200N/0612523W; 102157N/0612525W; 102158N/0612528W to the point of origin.	<u>2500FT</u> SFC	All UAS flights require prior authorization from the TTCAA, except those conducted for medical or national security operations.
TTR14U - TOBAGO PRISON Area bounded by lines joining the points 111046N/0604402W; 111048N/0604400W; 111045N/0604359W; 111044N/0604400W to the point of origin	<u>2500FT</u> SFC	All UAS flights require prior authorization from the TTCAA, except those conducted for medical or national security operations.
TTR15U - PIARCO INTERNATIONAL AIRPORT Circular area centered on 103543N/0612008W within a 5KM radius.	SFC	All UAS flights are prohibited except for operations conducted with special flight permission from the TTCAA
TTR16U-A.N.R. ROBINSON INTERNATIONAL AIRPORT Circular area centered on 110900N/0604957W within a 5KM radius.	SFC	All UAS flights are prohibited except for operations conducted with special flight permission from the TTCAA
TTR17U - CAMDEN Circular area centered on 102541N/0612644W within a 5KM radius.	SFC	All UAS flights are prohibited except for operations conducted with special flight permission from the TTCAA

- Note removed from top of table. New note added at bottom of table:

Note: The UAS Section of the TTCAA website contains all relevant information regarding Unmanned Aircraft Systems (UAS) in Trinidad and Tobago.

This includes the UAS Regulations, the UAS No-Fly Zones map, and descriptions of several processes that operators may undertake. The information can be accessed at:

<https://caa.gov.tt/licensing-certification/unmanned-aircraft-systems-uas-drones/>

The current UAS No Fly Zones Map can be found at:

<https://www.arcgis.com/apps/mapviewer/index.html?webmap=1c5f093e24594edfacc4ccb76fc98cc4>

Please amend Eastern Caribbean AIP pages ENR 5.1-2 and ENR 5.1-3.

AIP SUP 12/26 revises AIP SUP 08/26

END



PIARCO INTERNATIONAL NOTAM OFFICE

AIP SUPPLEMENT

Tele: 1 868 669-4128
1 868 668-8222 ext 2510
FAX: 1 868 669 1716
AFTN: TTPPYNYX
Email:aimpublication@caa.gov.tt

TRINIDAD & TOBAGO
CIVIL AVIATION AUTHORITY,
P.O. BOX 2163, NATIONAL MAIL CENTRE,
PIARCO
REPUBLIC OF TRINIDAD AND TOBAGO

11/26
24 MAR 26

AD

11. TERRANCE B. LETTSOME INTERNATIONAL AIRPORT (TUPJ)

Procedures for VFR Flights

Effective: 260324 to PERM

VFR flight procedures at Terrance B. Lettsome International Airport (TUPJ) are updated as follows:

Procedures for outbound aircraft

1. The 'default procedure' for all VFR aircraft departing RWY 07 westbound should make a left turn out after departure. When traffic permits, ATC may authorise a right turn and aircraft should proceed south of the island chain, 2000FT or below until clear of the RNAV-A (07) approach path when traffic is reported on the RNAV-A, or until otherwise advised by ATC. Those aircraft authorised to make a right turn should be established south of the island chain before crossing Cooper Island westbound.
2. In the absence of aircraft on the RNAV-A approach, ATC may provide a more direct routing; however, VFR aircraft making a right turn should still proceed south of the island chain westbound.

Procedures for inbound aircraft

1. When there is a potential conflict with RNAV-A arrivals, VFR aircraft inbound to TUPJ from the west and southwest that have been instructed to follow a preceding inbound aircraft should expect to hold approximately eight (8) miles or greater west or southwest of TUPJ, 2000FT or below (right turns) on the southwestern coast of Tortola or south of Norman Island until they have the preceding traffic in sight and can maintain their own separation, or unless otherwise advised by ATC. VFR aircraft inbound to TUPJ from the east and southeast should expect to hold south or southeast of Cooper Island. All aircraft are to remain clear of the RNAV-A (07) approach path once traffic is reported on the approach.
2. Visual Reporting Points (VRP) have been established at Sopers Hole (182309N 0644159W), Norman Island (181857N 0643650W) and Cooper Island (182237N 0643032W) as references for VFR aircraft to route and hold if necessary. VFR aircraft should attempt to establish radio contact with Beef Island ATC on 118.400MHz as early as possible before reaching the VRP to the west and southwest, and at least by 15NM inbound from the east.

3. When VFR aircraft is holding south of Cooper Island, ATC may instruct IFR traffic executing a missed approach on the RNAV-A (07) to maintain runway heading if necessary.

For more published AIP Supplements and NOTAM regarding BVIAA airports, you may visit:

<https://caa.gov.tt/notices-to-operators-notification/aip-sups/> and
https://caa.gov.tt/notices-to-operators-notification/#elf_11_Lw

END

**PIARCO INTERNATIONAL NOTAM OFFICE****AIP
SUPPLEMENT**

Tele: 1 868 669-4128
1 868 668-8222 ext 2510
FAX: 1 868 669 1716
AFTN: TTPPYNYX
Email:aimpublication@caa.gov.tt

TRINIDAD & TOBAGO
CIVIL AVIATION AUTHORITY,
P.O. BOX 2163, NATIONAL MAIL CENTRE,
PIARCO
REPUBLIC OF TRINIDAD AND TOBAGO

10/26
13 MAR 26

AD**10. ARGYLE INTERNATIONAL AIRPORT (TVSA)****AERODROME AND AIR TRAFFIC SERVICES (ATS) HOURS OF SERVICE**

Effective: 260313 to 260903

Aerodrome hours of service are now 0900 UTC to 0100 UTC.

Air Traffic Services (ATS) hours of service are now 1100 UTC to 0100 UTC. Prior permission required for operations outside of scheduled operating hours.

For operations outside of scheduled operating hours, forward all requests to AIA Operations at aiaoperations@svg-airports.com or **1-784-493-4764**.

AIP SUP 10/26 replaces AIP SUP 05/26.

END

Intentionally left blank

**PIARCO INTERNATIONAL NOTAM OFFICE****AIP
SUPPLEMENT**

Tele: 1 868 669-4128
1 868 668-8222 ext 2510
FAX: 1 868 669 1716
AFTN: TTPPYNYX
Email:aimpublication@caa.gov.tt

TRINIDAD & TOBAGO
CIVIL AVIATION AUTHORITY,
P.O. BOX 2163, NATIONAL MAIL CENTRE,
PIARCO
REPUBLIC OF TRINIDAD AND TOBAGO

09/26
13 MAR 26

AD**09. ROBERT L. BRADSHAW INTERNATIONAL AIRPORT (TKPK)****AVGAS Availability****Effective: 260313 to 270301**

Due to a shortage in fuel supply, AVGAS at Robert L. Bradshaw International Airport (TKPK) is **unavailable**.

AIP SUP 09/26 replaces NOTAM A0285/26.

END

Intentionally left blank

**PIARCO INTERNATIONAL NOTAM OFFICE****AIP
SUPPLEMENT**

Tele: 1 868 669-4128
1 868 668-8222 ext 2510
FAX: 1 868 669 1716
AFTN: TTPPYNYX
Email:aimpublication@caa.gov.tt

TRINIDAD & TOBAGO
CIVIL AVIATION AUTHORITY,
P.O. BOX 2163, NATIONAL MAIL CENTRE,
PIARCO
REPUBLIC OF TRINIDAD AND TOBAGO

07/26
03 MAR 26

AD**07. ST. VINCENT AND THE GRENADINES****Aerodrome Hours of Service Amended for J.F. Mitchell Airport (TVSB), Canouan Airport (TVSC) and Union Island Airport (TVSU)**

Effective: 260303 to 260602

Aerodrome hours of service for J.F. Mitchell Airport (TVSB), Canouan Airport (TVSC) and Union Island Airport (TVSU) are now 1100 UTC - SS.

AIP SUP 07/26 replaces AIP SUP 33/25.

END

Intentionally left blank

**PIARCO INTERNATIONAL NOTAM OFFICE****AIP
SUPPLEMENT**

Tele: 1 868 669-4128
1 868 668-8222 ext 2510
FAX: 1 868 669 1716
AFTN: TTPPYNYX
Email:aimpublication@caa.gov.tt

TRINIDAD & TOBAGO
CIVIL AVIATION AUTHORITY,
P.O. BOX 2163, NATIONAL MAIL CENTRE,
PIARCO
REPUBLIC OF TRINIDAD AND TOBAGO

06/26
03 MAR 26

AD**06. A.N.R. ROBINSON INTERNATIONAL AIRPORT (TTCP)****Pavement Strength Amended****Effective: 260303 to PERM**

The Pavement Strengths of the Aprons, Taxiways and Runways at the A.N.R. Robinson International Airport have been updated in the following pages of the Eastern Caribbean AIP:

AD 2.10-2-3**TTCP AD 2.8 APRONS, TAXIWAYS AND CHECK LOCATIONS DATA**

- Row 1 (Apron surface and strength)
Change Apron EASTERN to:
West Apron 1
Type of surface: Concrete
Strength: PCR 310/R/A/W/T

Change Apron WESTERN to:
West Apron 2
Type of surface: Concrete
Strength: PCR 913/R/A/W/T
- Row 2 (Taxiway width, surface and strength)
TWY A Strength: PCR 780/F/A/W/T
TWY B Strength: PCR 780/F/A/W/T
TWY C Strength: PCR 780/F/A/W/T

AD 2.10-2-5**TTCP AD 2.12 RUNWAY PHYSICAL CHARACTERISTICS**

- Column 4 (Strength (PCR) and surface of RWY and SWY)
RWY 11: PCR 731/F/A/W/T
RWY 29: PCR 731/F/A/W/T

AD 2.10-2-13

Amend Bearing Strength box at bottom right:

- RWY 11/29 - PCR 731/F/A/W/T
- TWY A, B, C - PCR 780/F/A/W/T
- Apron: West Apron 1 (Parking Positions 1-4) - PCR 310/R/A/W/T
West Apron 2 (Parking Positions 5-7) - PCR 913/R/A/W/T

Please amend Eastern Caribbean AIP pages AD 2.10-2-3, AD 2.10-2-5 and AD 2.10-2-13.

END

**PIARCO INTERNATIONAL NOTAM OFFICE****AIP
SUPPLEMENT**

Tele: 1 868 669-4128
1 868 668-8222 ext 2510
FAX: 1 868 669 1716
AFTN: TTPPYNYX
Email:aimpublication@caa.gov.tt

TRINIDAD & TOBAGO
CIVIL AVIATION AUTHORITY,
P.O. BOX 2163, NATIONAL MAIL CENTRE,
PIARCO
REPUBLIC OF TRINIDAD AND TOBAGO

04/26
26 FEB 26

GEN**04. JOHN A. OSBORNE AIRPORT****Twilight Limitations at John A. Osborne Airport****Effective: 260226 to PERM**

The Sunrise-Sunset table for John A. Osborne Airport is updated as follows:

Due to the limited duration of twilight at John A. Osborne Airport, the procedure of sunset plus thirty (30) minutes is not practicable. However, an extension of operations up to sunset plus twenty (20) minutes may be granted between February and September. For the period October to January, John A. Osborne Airport shall operate until 2200 UTC.

All requests for the extension of operating hours shall be submitted no later than 2130 UTC and are subject to prevailing weather conditions.

Please amend Eastern Caribbean AIP page GEN 2.7-12.

END

Intentionally left blank

**PIARCO INTERNATIONAL NOTAM OFFICE****AIP
SUPPLEMENT**

Tele: 1 868 669-4128
1 868 668-8222 ext 2510
FAX: 1 868 669 1716
AFTN: TTPPYNYX
Email:aimpublication@caa.gov.tt

TRINIDAD & TOBAGO
CIVIL AVIATION AUTHORITY,
P.O. BOX 2163, NATIONAL MAIL CENTRE,
PIARCO
REPUBLIC OF TRINIDAD AND TOBAGO

03/26
23 FEB 26

AD**03. JOHN A. OSBORNE AIRPORT****Aerodrome Chart - ICAO and Aerodrome Obstacle Chart - ICAO Type A - Operating Limitations at John A. Osborne Airport****Effective: 260223 to PERM**

The Aerodrome Chart - ICAO and Aerodrome Obstacle Chart - ICAO Type A - Operating Limitations at John A. Osborne Airport have been updated.

Please see attached:

- Attachment A – Aerodrome Chart – ICAO
- Attachment B – Aerodrome Obstacle Chart – ICAO Type A - Operating Limitations

Please refer to the Eastern Caribbean AIP pages AD 2.6-1-13 and AD 2.6-1-17.

END

Intentionally left blank

ATTACHMENT A

ARP 16°47'29"N 062°11'36"W

AD ELEV 550FT

John A. Osborne Airport
Gerald's
Montserrat

AERODROME CHART - ICAO



GUND (Geoid Undulation) = 416ft	
The height of the Geoid (MSL) above the Reference Ellipsoid (WGS84) at the stated position	
BEARINGS ARE MAGNETIC ELEVATIONS AND HEIGHTS ARE IN FEET	
ELEVATIONS IN FEET AMSL	467
HEIGHTS IN FEET ABOVE AD	(168)

RUNWAY/TAXIWAY/APRON PHYSICAL CHARACTERISTICS		
APRON/RWY/TWY	SURFACE	BEARING STRENGTH
RWY 10/28	Asphalt	16F/B/Y/T
TAXIWAY	Asphalt	7F/B/Y/T
MAIN APRON	Asphalt	7F/B/Y/T

DECLARED DISTANCES (metres)				
	TORA	TODA	ASDA	LDA
RWY 10	523	623	523	510
RWY 28	523	799	523	510

TORA for both runways starts 13m before the Thresholds

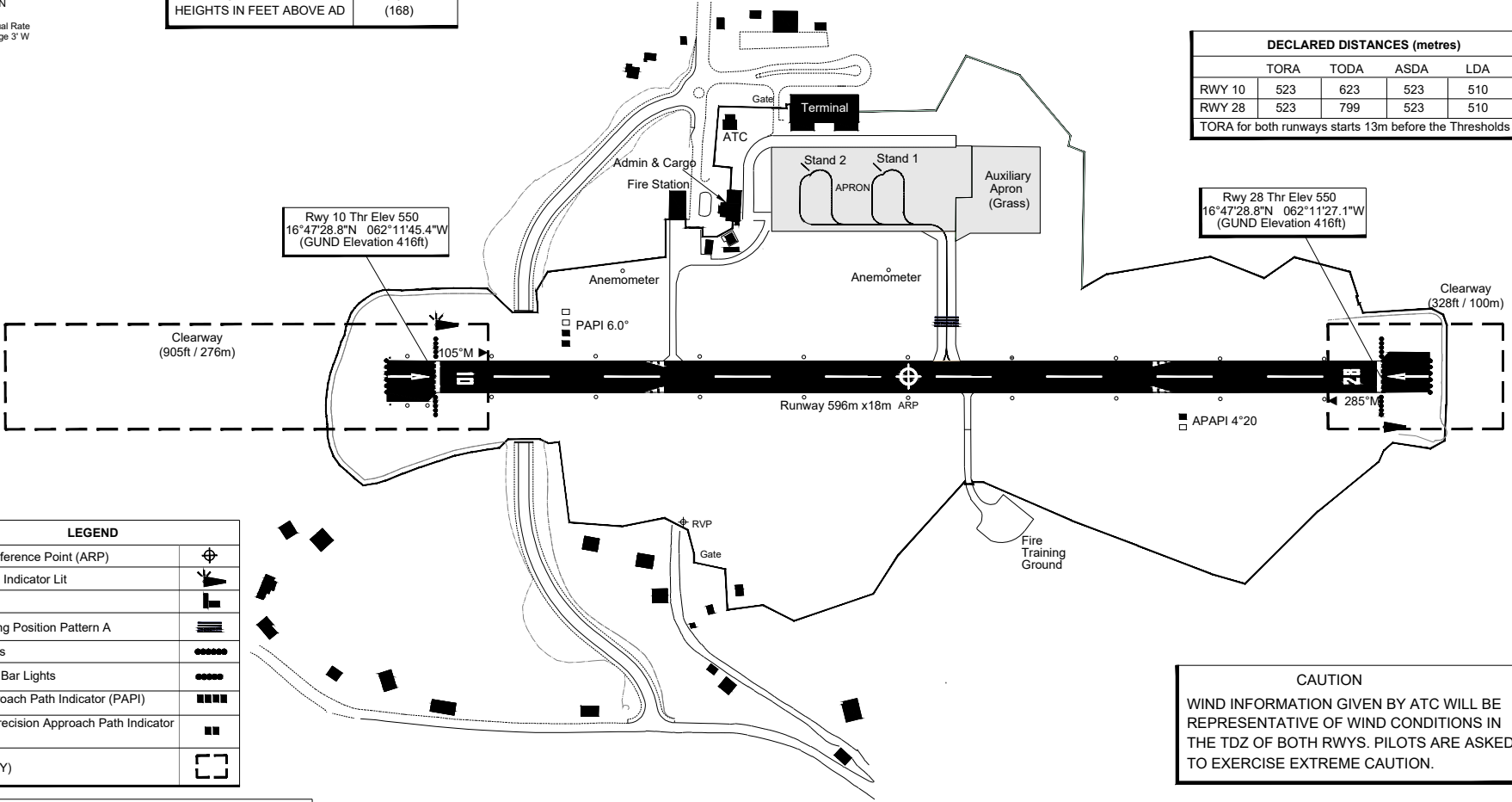

CAUTION
WIND INFORMATION GIVEN BY ATC WILL BE REPRESENTATIVE OF WIND CONDITIONS IN THE TDZ OF BOTH RWYS. PILOTS ARE ASKED TO EXERCISE EXTREME CAUTION.

LEGEND	
Aerodrome Reference Point (ARP)	⊕
Wind Direction Indicator Lit	▶
Buildings	■
Runway Holding Position Pattern A	▬▬▬
Rwy End Lights	●●●●●
Rwy Thr Wing Bar Lights	●●●●●
Precision Approach Path Indicator (PAPI)	■ ■ ■ ■
Abbreviated Precision Approach Path Indicator (APAPI)	■ ■
Clearway (CWY)	□ □ □ □

COM	
ATIS	Not Available
TWR	118.8MHz JOHN A. OSBORNE TOWER
LIGHTING	
THR 10/28	Green Wing bars
RWY 10/28	Hi White Edge 60m spacing, End lights red
RWY 10	PAPI-L (6.0°)
RWY 28	APAPI-L (4°20')
TWY	Blue edge

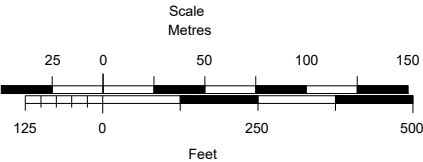

STAND	LATITUDE	LONGITUDE	ELEV (FT)
1	16°47'32.6"N	062°11'36.7"W	550
2	16°47'32.6"N	062°11'38.1"W	549

Intentionally left blank

ATTACHMENT B

ELEVATIONS IN FEET

ALL OTHER DIMENSIONS IN METRES

AERODROME OBSTACLE CHART - ICAO TYPE A - OPERATING LIMITATIONS

JOHN A. OSBORNE AIRPORT
GERALD'S, MONTSERRAT
RWY 10/28

MAGNETIC VARIATION 15° W - MAY 2024
Change 3' W per year

ORDER OF ACCURACY: Horizontal 3m; Vertical 1ft
Aerodrome information current May 2024
Based on survey dated May 2024

RUNWAY 10-28

DECLARED DISTANCES		
RWY 10		RWY 28
523	TAKE-OFF RUN AVAILABLE	523
623	TAKE-OFF DISTANCE AVAILABLE	799
523	ACCELERATE-STOP DISTANCE AVAILABLE	523
510	LANDING DISTANCE AVAILABLE	510

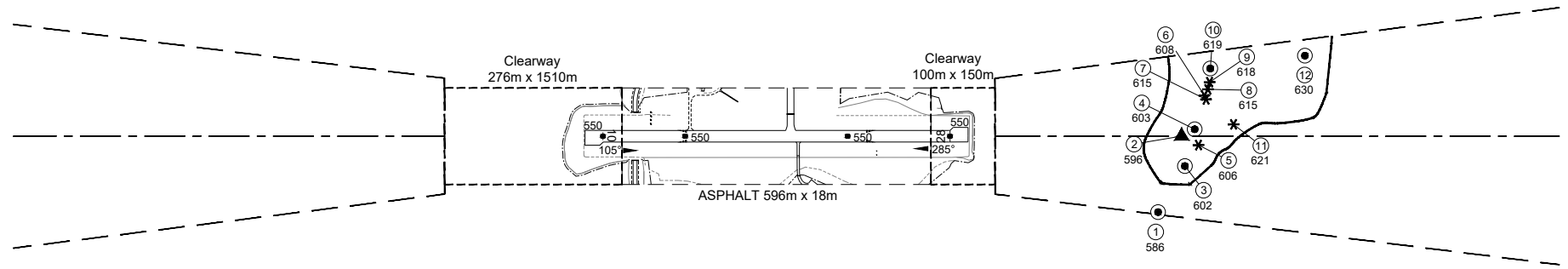
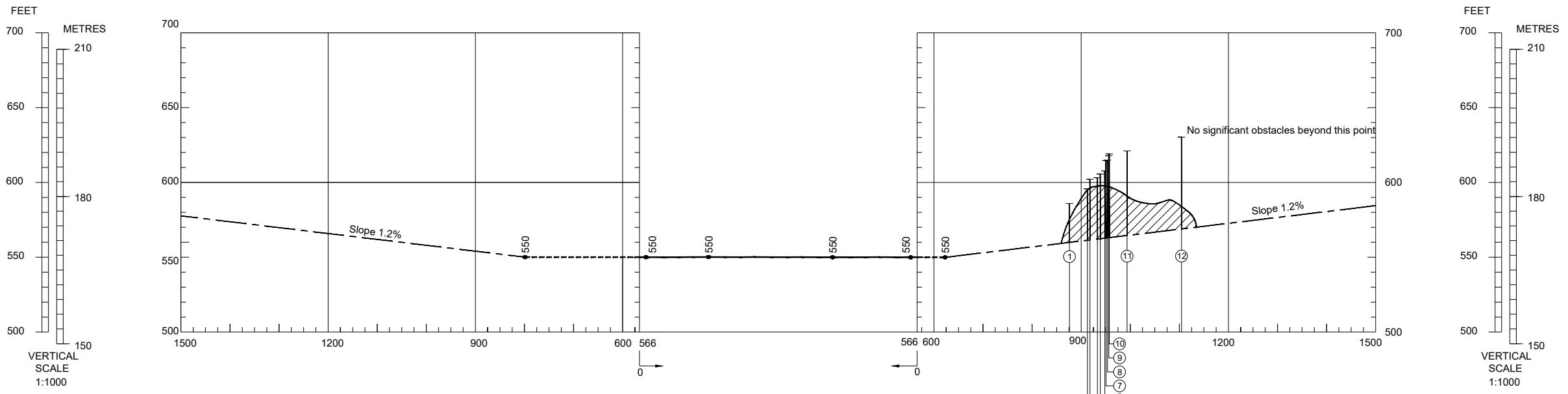

HORIZONTAL SCALE 1:10,000

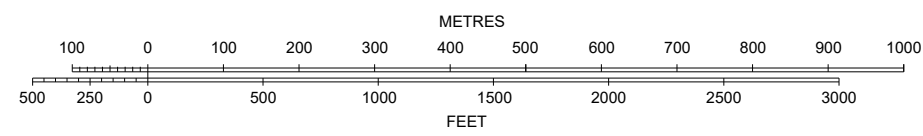

Obstacle Number	Survey Number	Description	Latitude	Longitude	ft
1	3117	EP	164725.01N	0621116.18W	586
2	608	Ground_Level	164728.85N	0621114.95W	596
3	3834	POLE	164727.34N	0621114.77W	602
4	3632	POLE	164729.20N	0621114.26W	603
5	3626	TREE	164728.40N	0621114.06W	606
6	3403	TREE	164730.90N	0621113.75W	608
7	3621	TREE	164730.71N	0621113.67W	615
8	3620	TREE	164731.22N	0621113.57W	615
9	3618	TREE	164731.58N	0621113.48W	618
10	3630	UTILITY_POLE	164732.27N	0621113.44W	619
11	3624	TREE	164729.45N	0621112.22W	621
12	3517	MAST	164732.92N	0621108.47W	630

LEGEND	PLAN	PROFILE
IDENTIFICATION NUMBER	⑤	⑤
HEIGHT AMSL	25	⑤
TREE / BUSH	*	⑤
POLE, AERIAL, TOWER, ETC	●	⑤
TERRAIN PENETRATING	⬮	⑤

Amendment Record		
No.	Date	Entered By

Intentionally left blank

**PIARCO INTERNATIONAL NOTAM OFFICE****AIP
SUPPLEMENT**

Tele: 1 868 669-4128
1 868 668-8222 ext 2510
FAX: 1 868 669 1716
AFTN: TTPPYNYX
Email:aimpublication@caa.gov.tt

TRINIDAD & TOBAGO
CIVIL AVIATION AUTHORITY,
P.O. BOX 2163, NATIONAL MAIL CENTRE,
PIARCO
REPUBLIC OF TRINIDAD AND TOBAGO

02/26
12 FEB 26

AD

02. JOHN A. OSBORNE AIRPORT**Aerodrome Meteorological Warnings Not Available****Effective: 260212 to 270210**

Aerodrome meteorological warnings not available at John A. Osborne Airport (TRPG).

END

Intentionally left blank

**PIARCO INTERNATIONAL NOTAM OFFICE****AIP
SUPPLEMENT**

Tele: 1 868 669-4128
1 868 668-8222 ext 2510
FAX: 1 868 669 1716
AFTN: TTPPYNYX
Email:aimpublication@caa.gov.tt

TRINIDAD & TOBAGO
CIVIL AVIATION AUTHORITY,
P.O. BOX 2163, NATIONAL MAIL CENTRE,
PIARCO
REPUBLIC OF TRINIDAD AND TOBAGO

01/26
23 JAN 26

AD**01. TERRANCE B. LETTSOME INTERNATIONAL AIRPORT (TUPJ)****Aerodrome Obstacles at Terrance B. Lettsome International Airport****Effective: 260123 to PERM**

The following are aerodrome obstacles at the Terrance B. Lettsome International Airport (TUPJ):

ID OBST/ Designation	OBST Type	OBST Coordinate	ELEV/HGT	Markings/Type, Colour of Light	Remarks
a	b	c	d	e	f
TUPJOB001	ATC Aerial	18 26 38.2N 064 32 19.0W	37M (119FT)	Antenna/LGTD	Atop ATC TWR
TUPJOB002	Apron Light	18 26 41.5N 064 32 20.8W	20M (65FT)	NIL	NIL
TUPJOB003	Building	18 25 51.1N 064 34 42.8W	234M (767FT)	NIL	NIL

Please see updated **Aerodrome Obstacle Chart - ICAO in Attachment A**, for a profile view of obstacles at the aerodrome.

Please amend the Eastern Caribbean AIP pages AD 2.3-1-4 and AD 2.3-1-17.

END

Intentionally left blank

ATTACHMENT A

AERODROME OBSTACLE CHART - ICAO TYPE A - OPERATING LIMITATIONS

Terrance B. Lettsome (Beef Island)
BRITISH VIRGIN ISLANDS, TORTOLA

ELEVATIONS IN FEET
ALL OTHER DIMENSIONS IN METRES

MAGNETIC VARIATION 14° W (May 2024)
Change 3' W per year

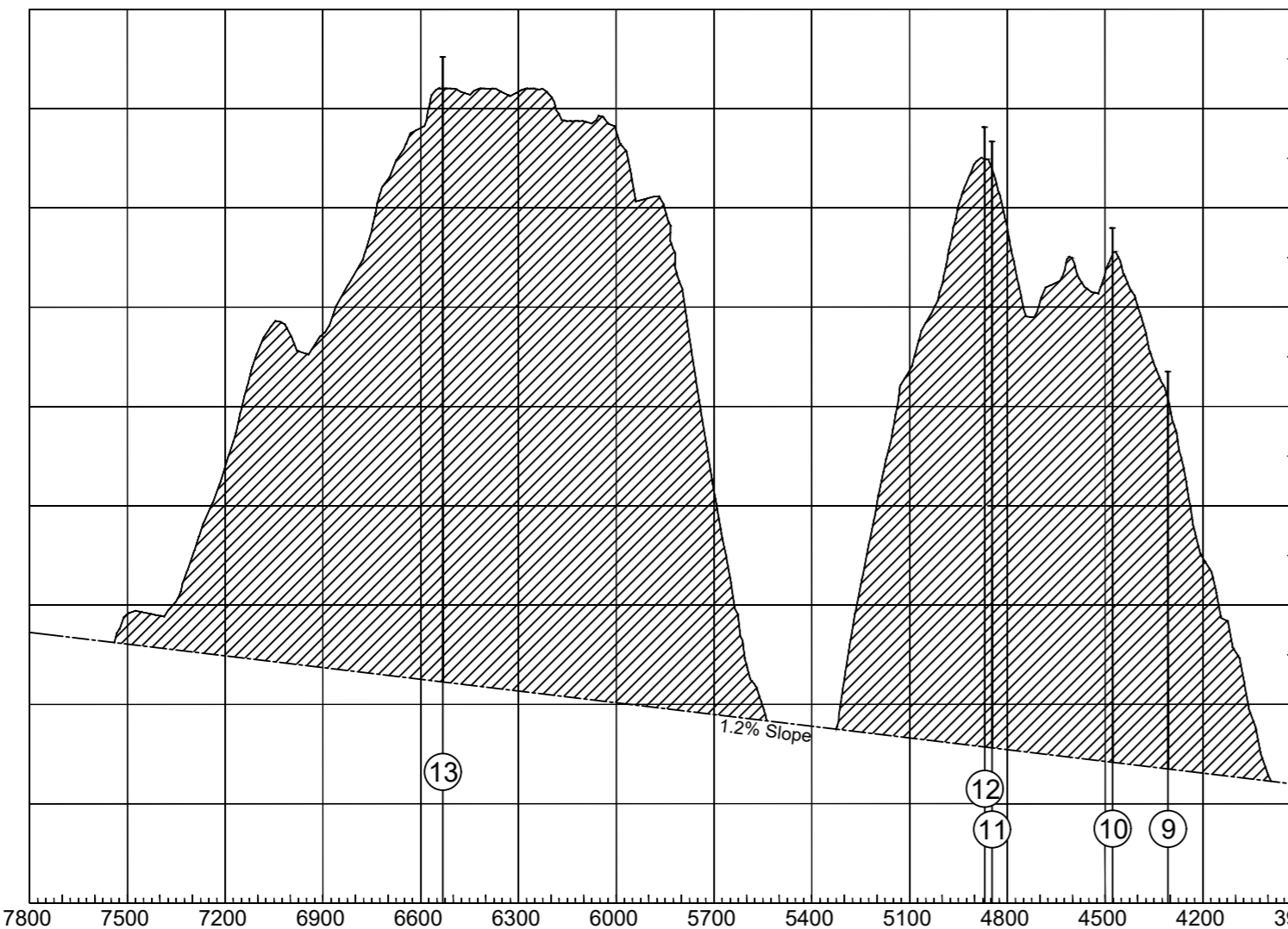
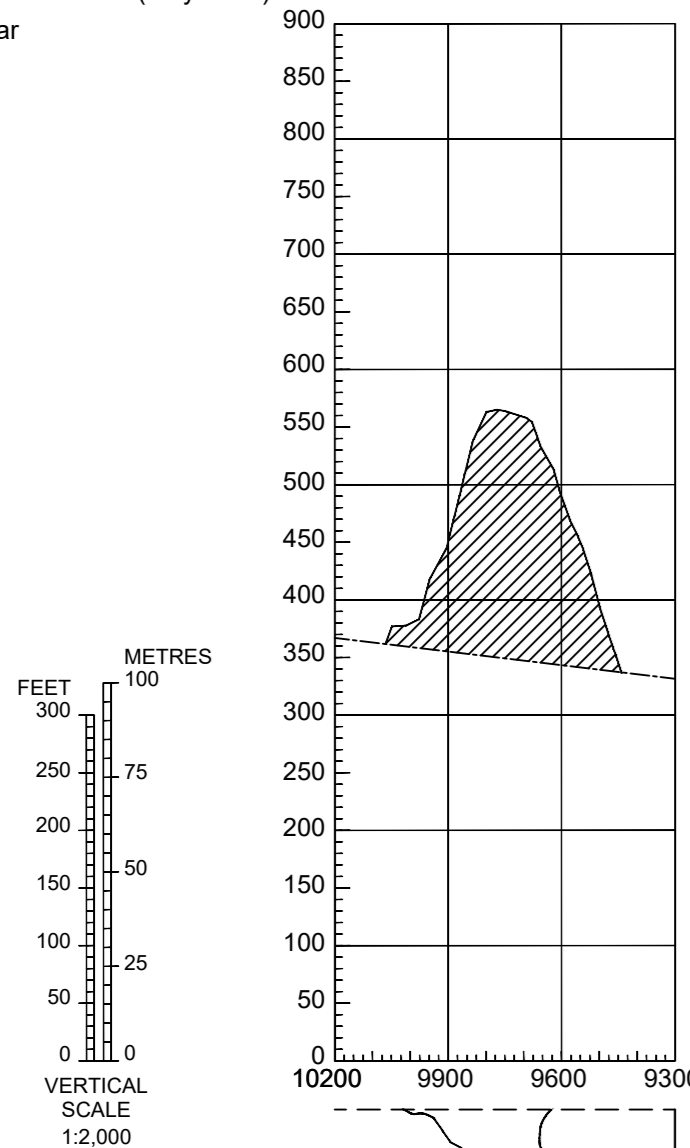

RUNWAY 07-25

DECLARED DISTANCES			
RWY 07			RWY 25
1355	TAKE-OFF RUN AVAILABLE		1266
1505	TAKE-OFF DISTANCE AVAILABLE		1326
1355	ACCELERATE-STOP DISTANCE AVAILABLE		1266
1206	LANDING DISTANCE AVAILABLE		1206

Obstacle Number	Survey Number	Description	Latitude	Longitude	Height m	Height ft
1	5597	BOAT_MAST	182700.9481N	0643155.4127W	17.40	57.10
2	1266	SPOT_HT	182805.5013N	0643028.6435W	133.50	437.99
3	5690	ANEMOMETER	182636.3661N	0643250.2298W	14.11	46.28
4	2001	TREE	182624.4879N	0643318.7481W	26.46	86.81
5	2000	TREE	182623.9358N	0643318.7694W	28.89	94.78
6	1998	TREE	182621.6756N	0643318.6216W	32.19	105.61
7	1997	TREE	182621.1078N	0643318.4542W	32.43	106.40
8	1639	TREE	182621.5532N	0643318.9933W	32.95	108.10
9	1051	BUSH	182548.0200N	0643419.8774W	163.08	535.03
10	2022	BUSH	182545.3673N	0643424.9581W	207.17	679.68
11	5580	BUILDING	182551.1339N	0643442.8244W	233.72	766.79
12	2024	BUSH	182550.1801N	0643443.1429W	238.14	781.29
13	1253	SPOT_HT	182516.2587N	0643528.1559W	259.69	851.99

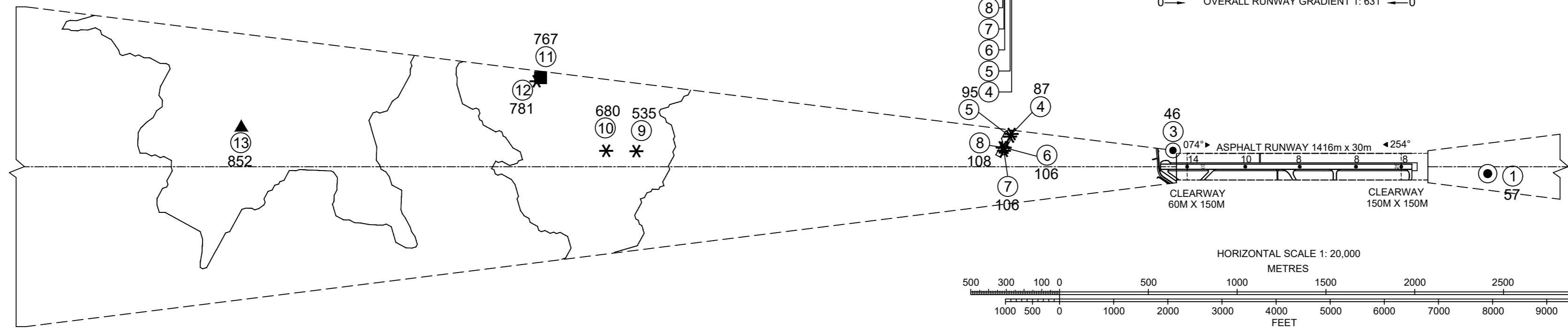
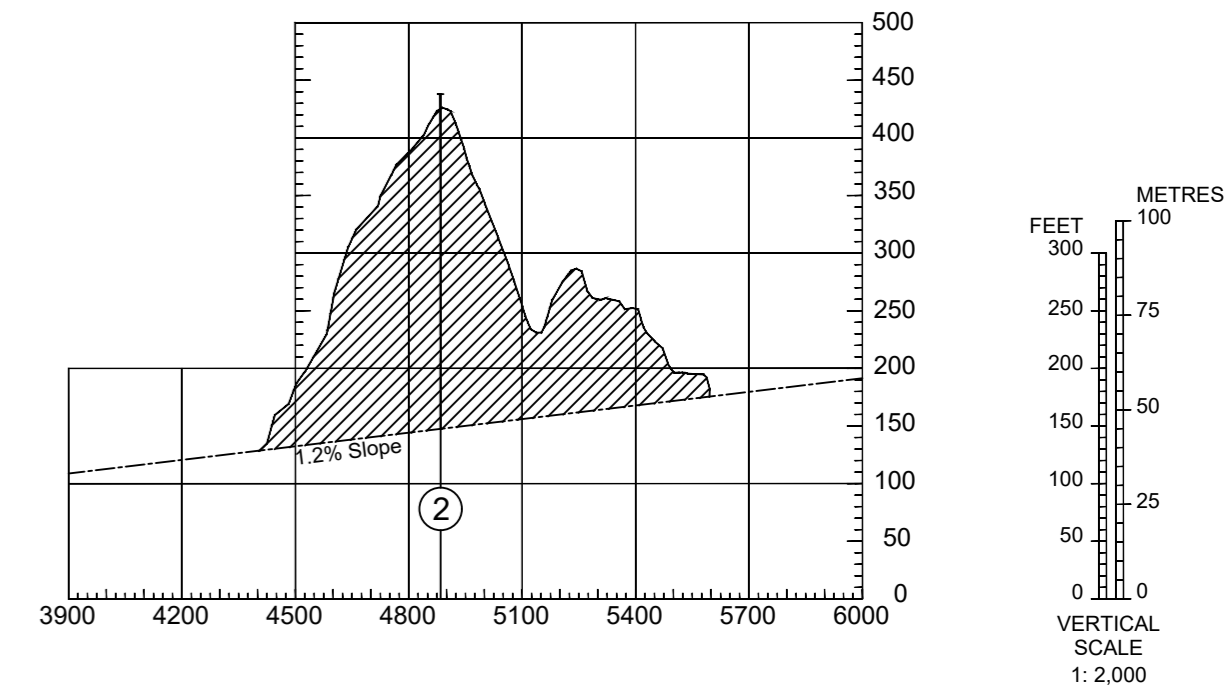

LEGEND	
	PLAN PROFILE
IDENTIFICATION NUMBER	⑤
HEIGHT AMSL	25
TREE / BUSH	* ⑥
POLE, AERIAL, TOWER, ETC	●
BUILDING	■
GROUND LEVEL	▲
TERRAIN PENETRATING	▨ ▩

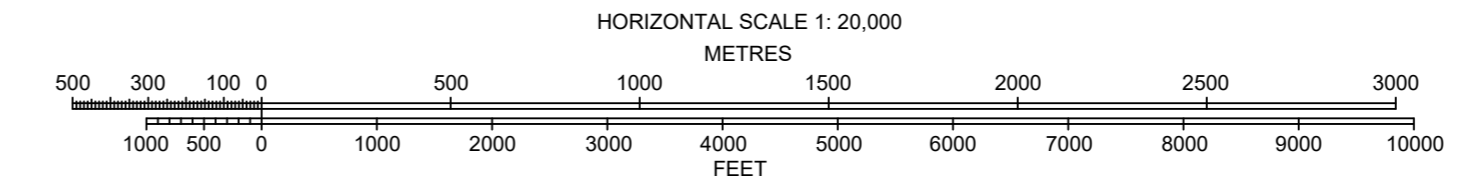

Amendment Record		
No.	Date	Entered By

ORDER OF ACCURACY: Horizontal 3m; Vertical 0.3m
Aerodrome information current MAY 2024
Based on survey dated MAY 2024

Intentionally left blank

**PIARCO INTERNATIONAL NOTAM OFFICE****AIP
SUPPLEMENT**

Tele: 1 868 669-4128
1 868 668-8222 ext 2510
FAX: 1 868 669 1716
AFTN: TTPPYNYX
Email:aimpublication@caa.gov.tt

TRINIDAD & TOBAGO
CIVIL AVIATION AUTHORITY,
P.O. BOX 2163, NATIONAL MAIL CENTRE,
PIARCO
REPUBLIC OF TRINIDAD AND TOBAGO

47/25
24 DEC 25

GEN**47. TERRANCE B. LETTSOME INTERNATIONAL AIRPORT (TUPJ)****RESTRICTIONS FOR USE OF BRITISH VIRGIN ISLANDS AIRSPACE****Effective: 251224 to 270105**

The United Kingdom Department for Transport has issued a regulation indicating that no aircraft that is owned, chartered or operated by a person connected with Russia, or which is registered in Russia, shall fly in the British Virgin Islands airspace, including in the airspace above the territorial sea.

This regulation does not apply to any aircraft flying by the permission of the UK Secretary for Transport.

Permission is available from Air Safety Support International at **enquiries@airsafety.aero**

AIP SUP 47/25 replaces AIP SUP 01/25.

END

Intentionally left blank

**PIARCO INTERNATIONAL NOTAM OFFICE****AIP
SUPPLEMENT**

Tele: 1 868 669-4128
1 868 668-8222 ext 2510
FAX: 1 868 669 1716
AFTN: TTPPYNYX
Email:aimpublication@caa.gov.tt

TRINIDAD & TOBAGO
CIVIL AVIATION AUTHORITY,
P.O. BOX 2163, NATIONAL MAIL CENTRE,
PIARCO
REPUBLIC OF TRINIDAD AND TOBAGO

46/25
23 DEC 25

AD**46. BRITISH VIRGIN ISLANDS****Aerodrome Meteorological Warnings Not Available****Effective: 251223 to 261223**

Aerodrome meteorological warnings not available at Terrance B. Lettsome International Airport (TUPJ), Auguste George Airport (TUPA) and Virgin Gorda Airport (TUPW).

END

Intentionally left blank

**PIARCO INTERNATIONAL NOTAM OFFICE****AIP
SUPPLEMENT**

Tele: 1 868 669-4128
1 868 668-8222 ext 2510
FAX: 1 868 669 1716
AFTN: TTPPYNYX
Email:aimpublication@caa.gov.tt

TRINIDAD & TOBAGO
CIVIL AVIATION AUTHORITY,
P.O. BOX 2163, NATIONAL MAIL CENTRE,
PIARCO
REPUBLIC OF TRINIDAD AND TOBAGO

45/25
18 DEC 25

GEN**45. ANTIGUA AND BARBUDA****Air Navigation Services Charges Amended****Effective: 260101 to PERM**

Route air navigation services charges and surcharge are amended for Antigua and Barbuda.

Route air navigation services

Aircraft weight (lbs)	Charge per landing (Eastern Caribbean currency) (EC)
Up to 12,500	\$80.00
12,501 - 75,000	\$120.00
Exceeding 75,000	\$270.00

Surcharge

If any of the above-mentioned fees remain unpaid for thirty days after payment has been demanded by the Antigua and Barbuda Airport Authority, a further sum equal to 10% of the unpaid fee shall be payable.

Please amend the Eastern Caribbean AIP pages GEN 4.2-2 and GEN 4.2-3

END

Intentionally left blank

**PIARCO INTERNATIONAL NOTAM OFFICE****AIP
SUPPLEMENT**

Tele: 1 868 669-4128
1 868 668-8222 ext 2510
FAX: 1 868 669 1716
AFTN: TTPPYNYX
Email:aimpublication@caa.gov.tt

TRINIDAD & TOBAGO
CIVIL AVIATION AUTHORITY,
P.O. BOX 2163, NATIONAL MAIL CENTRE,
PIARCO
REPUBLIC OF TRINIDAD AND TOBAGO

44/25
24 NOV 25

AD**44. OIL NUT BAY HELIPORT (TUON)****Aerodrome Data Updated****Effective: 251124 to PERM**

The aerodrome data below have been updated as follows:

TUON AD 3.3 OPERATIONAL HOURS

Row 1 (Heliport Administration):

Oil Nut Bay Management Office Operational Hours: 0900 - 0200

TUON AD 3.19 LOCAL HELIPORT REGULATIONS**1. Heliport Regulation**

1.1 All operations to/from the Oil Nut Bay Heliport need to be operated by pilots with the following experience:

- Commercial Helicopter License
- 1000 Total Flying Hours
- 1000 Flying Hours on Type

In addition, there is a Verbal Orientation Briefing Document which needs to be read by the pilot to familiarize themselves with the local heliport operations. The document will be disseminated to the point of contact when a prior permission request is made to the heliport.

1.2 VFR operations are allowed at night.

Conditions for VFR at night are applicable to aircraft in transit through the territorial airspace of the British Virgin Islands or intending to land at or depart from the TUON heliport.

Unless it is on a special VFR flight within a control zone, an aircraft flying at night must:

- (a) Establish and maintain two-way communications with air traffic control on the appropriate communication frequency, when available, and

(b) Be flown in accordance with the visibility and distance from cloud minima equal to or greater than that specified in rules 27 and 28, except that:

1. Rule 27 paragraph (2) and rule 28 paragraph (4) shall not apply,
2. The cloud ceiling shall not be less than 1500ft,
3. When operating inside or outside controlled airspace, at and below 3000ft AMSL or 1000ft above terrain, whichever is higher, the pilots shall maintain continuous sight of the surface, and

(c) Not fly at a height of less than 1000ft, or in the case of high terrain or in mountainous areas, at a height of less than 2000ft, above the highest obstacle within a distance of 5NM unless:

1. It is necessary for the aircraft to do so in order to take off or land, or
2. The aircraft flies at an altitude not exceeding 3000ft AMSL and remains clear of cloud and with the surface in sight and in a flight visibility of at least 5km.

1.3 Requests for night operations will be handled individually.

TUON AD 3.20 NOISE ABATEMENT PROCEDURES

Operations in accordance with the Oil Nut Bay Heliport Manual. For more information, contact the Duty Manager via telephone, 284-346-0013 or email, dmhp@oilnutbay.com

TUON AD 3.21 FLIGHT PROCEDURES

Operations in accordance with the Oil Nut Bay Heliport Manual. For more information, contact the Duty Manager via telephone, 284-346-0013 or email, dmhp@oilnutbay.com

Please amend Eastern Caribbean AIP pages AD 3.1-1 and AD 3.1-6

END

**PIARCO INTERNATIONAL NOTAM OFFICE****AIP
SUPPLEMENT**

Tele: 1 868 669-4128
1 868 668-8222 ext 2510
FAX: 1 868 669 1716
AFTN: TTPPYNYX
Email:aimpublication@caa.gov.tt

TRINIDAD & TOBAGO
CIVIL AVIATION AUTHORITY,
P.O. BOX 2163, NATIONAL MAIL CENTRE,
PIARCO
REPUBLIC OF TRINIDAD AND TOBAGO

43/25
11 NOV 25

AD**43. V.C. BIRD INTERNATIONAL AIRPORT (TAPA)****AERODROME DATA UPDATED****Effective: 251111 to PERM****TAPA AD 2.8 APRONS, TAXIWAYS AND CHECK LOCATIONS DATA**

Row 6 (Remarks) has been revised as follows:

TWY A available in daylight hours only and limited to ACFT 65,000lbs or less and wingspan 30M or less. TWY E is the decommissioned RWY 10.

TAPA AD 2.20 LOCAL TRAFFIC REGULATIONS

- **1.2 Airport Regulations/Restrictions** additional information included as follows:
All aircraft operating into and out of V.C. Bird International Airport shall utilise the services of one of the approved ground handling providers.
Self-handling is not permitted except for commercial air carriers approved by the Antigua and Barbuda Airport Authority (ABAA) to conduct self-handling operations.

Approved Ground Handlers:

- i) Aircraft operating for corporate and private purposes shall utilise the services of the approved Fixed Based Operator (FBO):
Parking Location: Disused RWY 10
 - a. Company Name: Signature Flight Support (SFS)
Phone: 1-268-462-2522; 1-407-235-9018/9019
Email: anu@signatureaviation.com

ii) Aircraft operating for commercial purposes shall utilise one of the following approved ground handling service providers or may conduct self-handling if specifically approved by the Antigua and Barbuda Airport Authority:

Parking Location: Commercial Apron (Stands 1-14)

a. Company Name: Airport Services Antigua Limited (ASA)

Phone: 1-268-484-1374; 1-268-562-6798

Email: ops@asaanu.com or asa@candw.ag

b. Company Name: Dispatch Service Antigua (DSA)

Phone: 1-268-562-4148; 1-268-464-8501/4148; 1-268-484-1360

Email: dsaops@dsaltd.info or dispatch@dsaltd.info

c. Company Name: Caribbean Airport Services (CAS)

Phone: 1-268-562-7607

Email: handling@cas-antigua.com

d. Company Name: Express Handlers Limited

Phone: 1-268-484-1416; 1-268-729-2712

Email: expresshandlers@gmail.com or expresshandlers2010@gmail.com

• **2.2 Taxiway – Limitations** revised as follows:

Taxiway A available in daylight hours only and limited to aircraft 65,000 pounds or less and wingspan 30M or less.

AIP SUP 43/25 replaces AIP SUP 20/25

END

**PIARCO INTERNATIONAL NOTAM OFFICE****AIP
SUPPLEMENT**

Tele: 1 868 669-4128
1 868 668-8222 ext 2510
FAX: 1 868 669 1716
AFTN: TTPPYNYX
Email:aimpublication@caa.gov.tt

TRINIDAD & TOBAGO
CIVIL AVIATION AUTHORITY,
P.O. BOX 2163, NATIONAL MAIL CENTRE,
PIARCO
REPUBLIC OF TRINIDAD AND TOBAGO

42/25
05 NOV 25

AD**42. DOUGLAS CHARLES INTERNATIONAL AIRPORT (TDPD)****NDB 'DOM' 273.0kHz Unserviceable****Effective: 251105 to 261103**

Due to the unserviceability of the NDB 'DOM' 273.0kHz, the NDB RWY 27 Instrument Approach is not available.

As a result, the following Instrument Approaches are to be used:

- RNAV GNSS Y RWY 27
- RNAV GNSS Z RWY 27

Please refer to AIP Supplement 03/25.

END

Intentionally left blank

**PIARCO INTERNATIONAL NOTAM OFFICE****AIP
SUPPLEMENT**

Tele: 1 868 669-4128
1 868 668-8222 ext 2510
FAX: 1 868 669 1716
AFTN: TTPPYNYX
Email:aimpublication@caa.gov.tt

TRINIDAD & TOBAGO
CIVIL AVIATION AUTHORITY,
P.O. BOX 2163, NATIONAL MAIL CENTRE,
PIARCO
REPUBLIC OF TRINIDAD AND TOBAGO

41/25
04 NOV 25

AD**41. DOUGLAS CHARLES INTERNATIONAL AIRPORT (TDPD)****PAPI Operating Light Intensity RWY 27 at Douglas Charles International Airport****Effective: 251104 to 261103**

PAPI lights for RWY 27 are at operating intensity setting three (3).

END

Intentionally left blank

**PIARCO INTERNATIONAL NOTAM OFFICE****AIP
SUPPLEMENT**

Tele: 1 868 669-4128
1 868 668-8222 ext 2510
FAX: 1 868 669 1716
AFTN: TTPPYNYX
Email:aimpublication@caa.gov.tt

TRINIDAD & TOBAGO
CIVIL AVIATION AUTHORITY,
P.O. BOX 2163, NATIONAL MAIL CENTRE,
PIARCO
REPUBLIC OF TRINIDAD AND TOBAGO

40/25
04 NOV 25

AD**40. CANEFIELD INTERNATIONAL AIRPORT (TDCF)****Surface Wind Speed and Direction Indicators Unserviceable at Canefield International
Airport****Effective: 251104 to 261103**

Runway 01/19 surface wind speed and direction indicators are unserviceable. As a result, wind speed and direction provided by air traffic control are estimated on windsock indications.

END

Intentionally left blank

**PIARCO INTERNATIONAL NOTAM OFFICE****AIP
SUPPLEMENT**

Tele: 1 868 669-4128
1 868 668-8222 ext 2510
FAX: 1 868 669 1716
AFTN: TTPPYNYX
Email:aimpublication@caa.gov.tt

TRINIDAD & TOBAGO
CIVIL AVIATION AUTHORITY,
P.O. BOX 2163, NATIONAL MAIL CENTRE,
PIARCO
REPUBLIC OF TRINIDAD AND TOBAGO

39/25
04 NOV 25

AD**39. CANEFIELD INTERNATIONAL AIRPORT (TDCF)****Fuel Prior Permission Required at Canefield International Airport****Effective: 251104 to 261103**

Forty eight (48) hours prior permission is required by all operators for Jet A1 fuel.

Requests can be forwarded to the following email addresses:

- operationssupervisor@cwdom.dm
- hbrumant@cwdom.dm
- cfamer@daspa.dm
- aim@daspa.dm

AIP SUP 39/25 replaces NOTAM 1123/25.

END

Intentionally left blank

**PIARCO INTERNATIONAL NOTAM OFFICE****AIP
SUPPLEMENT**

Tele: 1 868 669-4128
1 868 668-8222 ext 2510
FAX: 1 868 669 1716
AFTN: TTPPYNYX
Email: aimpublication@caa.gov.tt

TRINIDAD & TOBAGO
CIVIL AVIATION AUTHORITY,
P.O. BOX 2163, NATIONAL MAIL CENTRE, PIARCO
REPUBLIC OF TRINIDAD AND TOBAGO

38/25
29 OCT 25

GEN**38. DOUGLAS CHARLES INTERNATIONAL AIRPORT (TDPD)****Charges for Operations Outside Normal Aerodrome Hours at Douglas Charles International Airport****Effective Date: 251029 to PERM**

Effective immediately, the following additional aerodrome charges are in effect at the Douglas Charles International Airport:

For hours between 0000 to 0200 UTC, a fee of 1325 XCD (510 USD) per hour or part thereof.

For hours after 0200 UTC, a fee of 2650 XCD (1020 USD) per hour or part thereof.

Please amend the Eastern Caribbean AIP page GEN 4.1-9

END

Intentionally left blank

**PIARCO INTERNATIONAL NOTAM OFFICE****AIP
SUPPLEMENT**

Tele: 1 868 669-4128
1 868 668-8222 ext 2510
FAX: 1 868 669 1716
AFTN: TTPPYNYX
Email:aimpublication@caa.gov.tt

TRINIDAD & TOBAGO
CIVIL AVIATION AUTHORITY,
P.O. BOX 2163, NATIONAL MAIL CENTRE,
PIARCO
REPUBLIC OF TRINIDAD AND TOBAGO

**37/25
21 OCT 25**

AD**37. A.N.R. ROBINSON INTERNATIONAL AIRPORT (TTCP)****Aerodrome Obstacles at A. N. R. Robinson International Airport****Effective: 251021 to PERM**

The following additional aerodrome obstacles in Area 2, for the A.N.R. Robinson International Airport (TTCP) are established:

ID OBST/ Designation	OBST Type	OBST Coordinate	ELEV/HGT	Markings/Type, Colour of Light	Remarks
a	b	c	d	e	f
TTCP0B012	MET Building	11 09 04.4N 060 49 50.1W	27M(89FT)/14M(47FT)	LGTD	NIL
TTCP0B013	Antenna	11 09 03.6N 060 49 51.9W	23M(75FT)/11M(36FT)	Red & White markings/ Red Light	NIL

Please amend the Eastern Caribbean AIP pages AD 2.10-2-4

END

Intentionally left blank

**PIARCO INTERNATIONAL NOTAM OFFICE****AIP
SUPPLEMENT**

Tele: 1 868 669-4128
1 868 668-8222 ext 2510
FAX: 1 868 669 1716
AFTN: TTPPYNYX
Email:aimpublication@caa.gov.tt

TRINIDAD & TOBAGO
CIVIL AVIATION AUTHORITY,
P.O. BOX 2163, NATIONAL MAIL CENTRE,
PIARCO
REPUBLIC OF TRINIDAD AND TOBAGO

36/25
14 OCT 25

AD**36. TERRANCE B. LETTSOME INTERNATIONAL AIRPORT (TUPJ)****Update to Aerodrome/Heliport Chart and Aircraft Parking/Docking Chart for Terrance B. Lettsome International Airport (TUPJ)****Effective: 251014 to PERM**

The following information have been updated for the Terrance B. Lettsome International Airport (TUPJ):

- Taxiway Contingency

Identified hotspots in the area of RWY 07 threshold, pose an increased risk of runway incursions. Insufficient visual range of Taxiway Alpha and Taxiway Bravo from the Control Tower due to obstacle, increases the safety risk to aircraft.

All pilots will be required to report once vacated of the active runway, when using Taxiway Alpha or Taxiway Bravo.

Further instructions will be given to each aircraft by the Control Tower.

- Update to the Aerodrome/Heliport Chart – ICAO, to include corrected RWY 07/25 THR coordinates and THR elevations, as well as hot spots located at TWY A and TWY B.

Please see Attachment A for updated chart.

- Aircraft Parking/Docking Chart. (Attachment B).

AIP SUP 36/25 replaces AIP SUP 31/25.

END

Intentionally left blank

ATTACHMENT A

AERODROME CHART - ICAO

ARP 18°26'44"N 064°32'30"W

AD ELEVATION 16FT

**Terrance B. Lettsome International Airport
Beef Island
British Virgin Islands**

ATS COMMUNICATION FACILITIES			
Service	Call Sign	Channel	Remarks
ATIS	NIL	127.750MHz	Nil
GND	Beef Island Ground	121.900MHz	Clearance delivery and Start-up request only
TWR	Beef Island Tower	118.400MHz	Approach Control Service provided by San Juan CERAP Freq: 128.65 MHz; 132.25 MHz
		121.500MHz	Emergency Frequency

GUND (Geoid Undulation) = The height of the Geoid (MSL) above the Reference Ellipsoid (WGS84) at the stated position	
BEARINGS ARE MAGNETIC ELEVATIONS AND HEIGHTS ARE IN FEET	
ELEVATIONS IN FEET AMSL	192
HEIGHTS IN FEET ABOVE AD	(68)

	DECLARED DISTANCES (metres)			
	TORA	TODA	ASDA	LDA
RWY 07	1356	1506	1356	1206
RWY 25	1266	1326	1266	1206

Threshold 07 displaced 150M from RWY End
Threshold 25 displaced 60M from RWY End

RUNWAY/TAXIWAY/APRON PHYSICAL CHARACTERISTICS		
APRON/RWY/TWY	SURFACE	BEARING STRENGTH
RWY 07/25	Asphalt	PCN 29/F/B/X/T
TWY A, B, C, D, E	Asphalt	PCN 16/F/C/X/T
MAIN APRON	Asphalt	PCN 16/F/C/X/T

LIGHTING	
ABN/IBN	ABN : Atop TWR Bldg – Green and White
THR 07/25	Green Wing bars
RWY 07/25	White Edge 60m spacing, End lights red
RWY 07	PAPI-L (3.5°)
RWY 25	PAPI-L (3.5°)
TWY A, B, C, D, E	Blue Edge

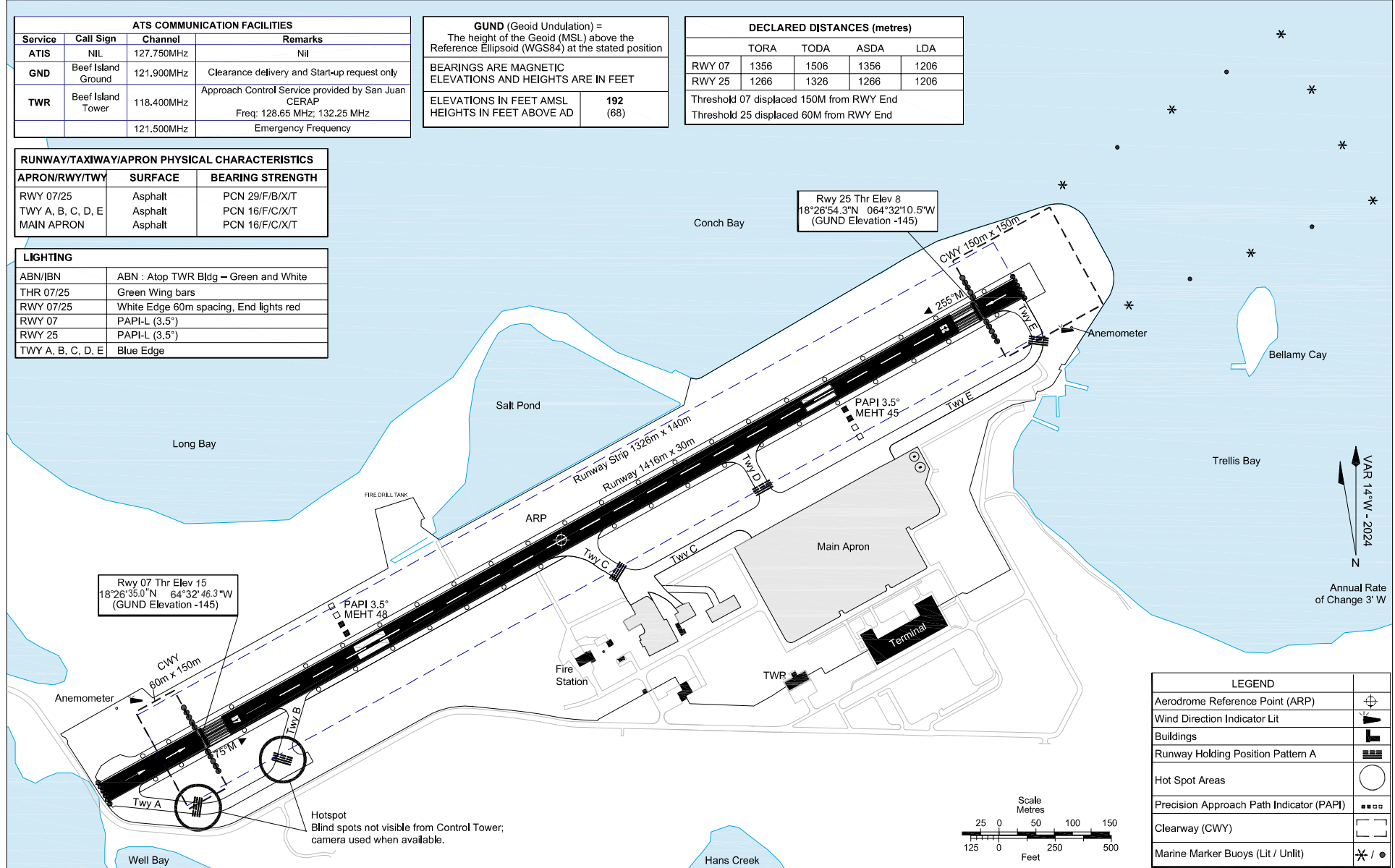

CHANGE : Updated RWY 07/25 THR coordinates and THR elevations

LEGEND	
Aerodrome Reference Point (ARP)	⊕
Wind Direction Indicator Lit	↗
Buildings	■
Runway Holding Position Pattern A	▬▬▬
Hot Spot Areas	○
Precision Approach Path Indicator (PAPI)	■ ■ ■ ■
Clearway (CWY)	□
Marine Marker Buoys (Lit / Unlit)	* / ●

Intentionally left blank

ATTACHMENT B

**AIRCRAFT PARKING/DOCKING
CHART - ICAO**

APRON ELEVATION 8FT

TWR	118.4
GND	121.9

**Terrance B. Lettsome International Airport
Beef Island
British Virgin Islands**

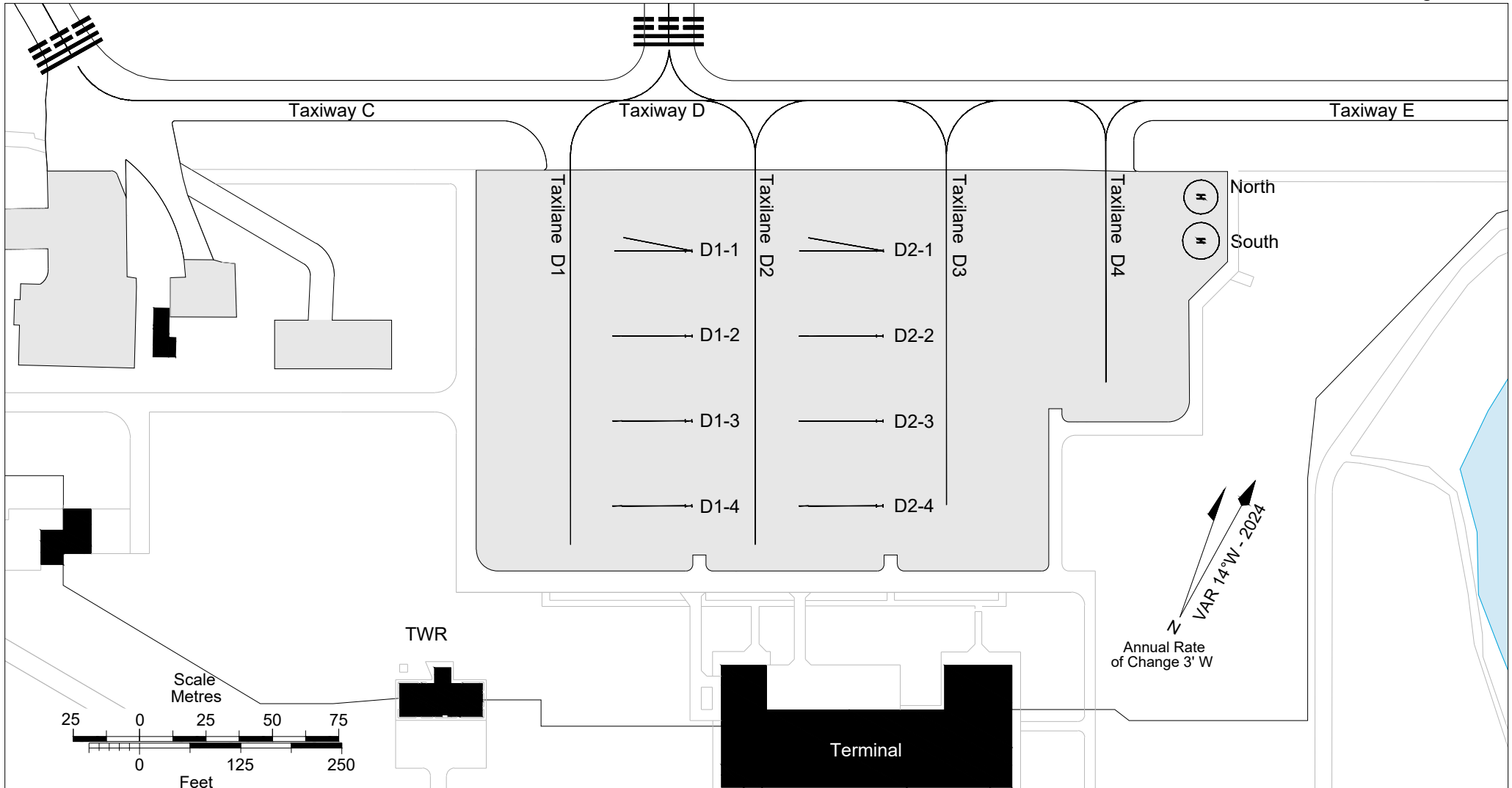

STAND	LATITUDE	LONGITUDE	ELEV (FT)
D1-1	18°26'44.1"N	064°32'18.8"W	8
D1-2	18°26'43.2"N	064°32'18.3"W	9
D1-3	18°26'42.3"N	064°32'17.8"W	9
D1-4	18°26'41.4"N	064°32'17.2"W	10
D2-1	18°26'45.3"N	064°32'16.7"W	7
D2-2	18°26'44.4"N	064°32'16.1"W	8
D2-3	18°26'43.5"N	064°32'15.6"W	9
D2-4	18°26'42.6"N	064°32'15.1"W	10

HELIPAD	LATITUDE	LONGITUDE	ELEV (FT)
NORTH	18°26'47.8"N	064°32'13.5"W	5
SOUTH	18°26'47.3"N	064°32'13.2"W	6

LEGEND	
Buildings	
Runway Holding Position Pattern A	
Helipad	
Aircraft Stand	D1-1

Intentionally left blank

**PIARCO INTERNATIONAL NOTAM OFFICE****AIP
SUPPLEMENT**

Tele: 1 868 669-4128
1 868 668-8222 ext 2510
FAX: 1 868 669 1716
AFTN: TTPPYNYX
Email:aimpublication@caa.gov.tt

TRINIDAD & TOBAGO
CIVIL AVIATION AUTHORITY,
P.O. BOX 2163, NATIONAL MAIL CENTRE,
PIARCO
REPUBLIC OF TRINIDAD AND TOBAGO

35/25
01 OCT 25

AD**35. MAURICE BISHOP INTERNATIONAL AIRPORT (TGPY)****NDB 'GND' Decommissioned****Effective: 251001 to PERM**

TGPY NDB 'GND' 362.0kHz, located at 12 00 29N 061 46 48W has been decommissioned. As a result, the NDB RWY 10 Instrument Approach (AD 2.5-2-27) has been withdrawn.

Please amend Eastern Caribbean AIP pages GEN 2.5-1, GEN 3.2-4, ENR 4.1-2, AD 2.5-2-7, AD 2.5-2-9, AD 2.5-2-10, AD 2.5-2-11, AD 2.5-2-13, AD 2.5-2-15, AD 2.5-2-19, AD 2.5-2-28, AD 2.5-2-29

END

Intentionally left blank



PIARCO INTERNATIONAL NOTAM OFFICE

AIP SUPPLEMENT

Tele: 1 868 669-4128
1 868 668-8222 ext 2510
FAX: 1 868 669 1716
AFTN: TTPPYNYX
Email:aispublications@caa.gov.tt

TRINIDAD & TOBAGO
CIVIL AVIATION AUTHORITY,
P.O. BOX 2163, NATIONAL MAIL CENTRE,
PIARCO
REPUBLIC OF TRINIDAD AND TOBAGO

34/25
17 SEP 25

ENR

34. PIARCO FIR (TTZP)

SUGGESTED ROUTINGS TO BE UTILIZED WITHIN THE PIARCO FIR DUE TO THE REMOVAL OF THE UA550, UA551 AND UA561 ROUTES

Effective: 250917 to 260930

The reorganization of the Piarco Flight Information Region is being implemented in a phased approach.

Currently, based on collaboration with all stakeholders, the upper airspace has been redesigned taking into account the Performance Based Navigation (PBN) concept. In addition, through the CANSO/IATA/ICAO Free Route Airspace (CIIFRA) initiative, a number of pre-approved optimized routes have been implemented.

The next phase of the airspace optimization project involves the connection of the new/revised upper airspace routes to the lower airspace arrival and departure routes into the aerodromes within the Piarco FIR. The implementation of this phase is expected to take place over 2026/2027.

Aircraft Operators and Flight Dispatchers are urged to please take note of the following:

- RNAV 5 routes implemented in the Piarco FIR which have been incorporated into the Eastern Caribbean AIP (ENR 3.2):

- UP533
- UN669
- UP410
- UM662

- Conventional routes which have been removed from the Piarco FIR:

- UA550
- UA551
- UA561

With regards to flights that previously utilized the UA550, UA551 and UA561 between the Piarco and Maiquetia FIRs, the following are suggested routings to be filed in the interim until the full implementation of the Piarco FIR Airspace Optimization is completed:

(a) Aircraft landing/departing TAPA that previously utilized the UA550, may file: ITEGO DCT DUNTA DCT ANU or the reciprocal.

(b) Aircraft landing/departing TFFR that previously utilized the UA550, may file: ITEGO DCT PPR or the reciprocal.

(c) Aircraft landing/departing TFFF that previously utilized the UA551, may file: ONGAL DCT FOF or the reciprocal.

(d) Aircraft landing/departing TLPL that previously utilized the UA551, may file: ONGAL DCT BNE or the reciprocal

(e) Aircraft landing/departing TGPY that previously utilized the UA561, may file: ILVAS DCT GND or the reciprocal.

(f) Aircraft landing/departing TBPB that previously utilized the UA561, may file: ILVAS DCT BGI or the reciprocal.

(g) Aircraft landing/departing TVSA that previously utilized the UA561, may file: ILVAS DCT SV or the reciprocal.

NOTE: Notwithstanding the above suggested routings, any flight entering the Piarco CTA/UTA from the Maiquetia FIR may file from any waypoint along the Piarco/Maiquetia boundary to a destination aerodrome WITHIN the Piarco CTA/UTA.

Questions or alternative requests regarding these interim procedures can be directed to:

- **Riaaz Mohammed - Manager ANS Planning and Development (rmohammed@caa.gov.tt)**
- **Ian Gomez - Manager Air Traffic Services and Air Navigation Services Safety (igomez@caa.gov.tt)**

AIP SUP 34/25 revises AIP SUP 21/24

END

**PIARCO INTERNATIONAL NOTAM OFFICE****AIP
SUPPLEMENT**

Tele: 1 868 669-4128
1 868 668-8222 ext 2510
FAX: 1 868 669 1716
AFTN: TTPPYNYX
Email:aimpublication@caa.gov.tt

TRINIDAD & TOBAGO
CIVIL AVIATION AUTHORITY,
P.O. BOX 2163, NATIONAL MAIL CENTRE,
PIARCO
REPUBLIC OF TRINIDAD AND TOBAGO

32/25
10 SEP 25

AD**32. LAURISTON AIRPORT (TGPZ)****Amendment to Approach and Runway Lighting for RWY 09 at Lauriston Airport (TGPZ)****Effective: 250910 to PERM**

Column 4 of TGPZ AD 2.14 Approach and Runway Lighting table to be amended to include an APAPI for RWY 09, configured to provide a glide slope of four (4) degrees.

Please amend Eastern Caribbean AIP page AD 2.5-1-5.

AIP SUP 32/25 replaces NOTAM A1283/25

END

Intentionally left blank

**PIARCO INTERNATIONAL NOTAM OFFICE****AIP
SUPPLEMENT**

Tele: 1 868 669-4128
1 868 668-8222 ext 2510
FAX: 1 868 669 1716
AFTN: TTPPYNYX
Email:aimpublication@caa.gov.tt

TRINIDAD & TOBAGO
CIVIL AVIATION AUTHORITY,
P.O. BOX 2163, NATIONAL MAIL CENTRE,
PIARCO
REPUBLIC OF TRINIDAD AND TOBAGO

29/25
21 AUG 25

AD**29. TERRANCE B. LETTSOME INTERNATIONAL AIRPORT (TUPJ)****AMENDMENTS TO PROCEDURES FOR VFR FLIGHTS****Effective: 250821 to PERM**

The procedures for VFR flights have been amended as follows:

1. Procedures for outbound aircraft

- All aircraft departing RWY 07 for a left turn shall maintain runway heading until level at or passing 1000FT (QNH) before commencing a left turn.
- All aircraft departing RWY 07 for a right turn westbound are required to proceed south of the island chain, at or below 2000FT, until clear of the RNAV-A 07 Approach path. Aircraft should be established south of the island chain before crossing Cooper Island unless otherwise advised by ATC.

2. Procedures for inbound aircraft

- All aircraft inbound from the west and south west that have been instructed to follow a preceding inbound aircraft are required to hold (right turns only) 8 miles or greater to the west of TUPJ, at or below 2000FT, on the south western coast of Tortola until reporting the preceding traffic in sight and can maintain their own separation unless otherwise advised by ATC.
- All aircraft inbound from the east and south east are required to hold south of Cooper Island until reporting the preceding traffic in sight and can maintain their own separation. All aircraft are to remain clear of the RNAV 07 Approach path once traffic is reported on the Approach.

Please refer to the Eastern Caribbean AIP: TUPJ AD 2.22 Flight Procedures

END

Intentionally left blank

**PIARCO INTERNATIONAL NOTAM OFFICE****AIP
SUPPLEMENT**

Tele: 1 868 669-4128
1 868 668-8222 ext 2510
FAX: 1 868 669 1716
AFTN: TTPPYNYX
Email:aimpublication@caa.gov.tt

TRINIDAD & TOBAGO
CIVIL AVIATION AUTHORITY,
P.O. BOX 2163, NATIONAL MAIL CENTRE,
PIARCO
REPUBLIC OF TRINIDAD AND TOBAGO

28/25
30 JUN 25

AD**28. PIARCO INTERNATIONAL AIRPORT (TTPP)****NDB 'TRI' UNSERVICEABLE****Effective: 250630 to 260630**

TTPP NDB 'TRI' 382.0KHz unserviceable.

AIP SUP 28/25 replaces AIP SUP 18/24

END

Intentionally left blank

**PIARCO INTERNATIONAL NOTAM OFFICE****AIP
SUPPLEMENT**

Tele: 1 868 669-4128
1 868 668-8222 ext 2510
FAX: 1 868 669 1716
AFTN: TTPPYNYX
Email:aimpublication@caa.gov.tt

TRINIDAD & TOBAGO
CIVIL AVIATION AUTHORITY,
P.O. BOX 2163, NATIONAL MAIL CENTRE,
PIARCO
REPUBLIC OF TRINIDAD AND TOBAGO

27/25
12 JUN 25

AD**27. PIARCO FIR (TTZP)****CHANGE IN AIRPORT NAME****Effective: 250612 to PERM**

Pointe-a-Pitre Le Raizet International Airport (TFFR) has been changed to Guadeloupe Maryse Conde International Airport (TFFR).

Please amend Eastern Caribbean AIP pages GEN 2.4-1, GEN 2.5-1, GEN 3.1-4, GEN 3.3-4, GEN 3.6-1, ENR 3.1 A312-1, ENR 3.1 A517-1, ENR 3.1 A550-1, ENR 3.1 R888-1, ENR 3.1 UA312-1, ENR 3.1 UR888-1, ENR 3.3-1, ENR 3.3-2, ENR 4.1-2

END

Intentionally left blank

**PIARCO INTERNATIONAL NOTAM OFFICE****AIP
SUPPLEMENT**

Tele: 1 868 669-4128
1 868 668-8222 ext 2510
FAX: 1 868 669 1716
AFTN: TTPPYNYX
Email:aimpublication@caa.gov.tt

TRINIDAD & TOBAGO
CIVIL AVIATION AUTHORITY,
P.O. BOX 2163, NATIONAL MAIL CENTRE,
PIARCO
REPUBLIC OF TRINIDAD AND TOBAGO

26/25
02 JUN 25

AD**26. JOHN A. OSBORNE INTERNATIONAL AIRPORT (TRPG)****AIR TRAFFIC SERVICES (ATS) LIMITATIONS****Effective: 250602 to 260529**

Due to the unserviceability of the Silver Hills High Site, ATS provided in certain regions are degraded. This affects the provision of full ATS, with limitations in traffic advisories as well as emergency and safety-related services.

END

Intentionally left blank

**PIARCO INTERNATIONAL NOTAM OFFICE****AIP
SUPPLEMENT**

Tele: 1 868 669-4128
1 868 668-8222 ext 2510
FAX: 1 868 669 1716
AFTN: TTPPYNYX
Email:aimpublication@caa.gov.tt

TRINIDAD & TOBAGO
CIVIL AVIATION AUTHORITY,
P.O. BOX 2163, NATIONAL MAIL CENTRE,
PIARCO
REPUBLIC OF TRINIDAD AND TOBAGO

25/25
16 MAY 25

AD**25. PIARCO INTERNATIONAL AIRPORT (TTPP)****PAVEMENT STRENGTH AMENDED****Effective Date: 250516 to PERM**

The Pavement Strength of the Apron, Taxiway, Runway and Stopway at the Piarco International Airport has been revised in the following tables:

TTPP AD 2.8 APRONS, TAXIWAYS AND CHECK LOCATIONS DATA

- Row 1 (Apron surface and strength)
 - Apron North Apron Strength: PCR 980/R/A/W/T
 - Apron South Apron Strength (Concrete): PCR/740/R/A/W/T
 - Apron South Apron Strength (Asphalt): PCR/570 F/A/X/T

- Row 2 (Taxiway width, surface and strength)
 - TWY at A1 Strength: PCR 718/F/A/X/T
 - TWY at A2 Strength: PCR 718/F/A/X/T
 - TWY at A3 Strength: PCR 718/F/A/X/T
 - TWY at B1 Strength: PCR 718/F/A/X/T
 - TWY at B3 Strength: PCR 718/F/A/X/T
 - TWY at C Strength: PCR 460/F/A/X/T
 - TWY at D Strength: PCR 270/F/A/X/T

- Row 6 (Remarks)
 - NIL

TTPP AD 2.12 RUNWAY PHYSICAL CHARACTERISTICS

- Column 4 (Strength (PCR) and surface of RWY and SWY)
 - RWY 10: PCR 718/F/A/X/T
 - RWY 28: PCR 718/F/A/X/T

Please amend Eastern Caribbean AIP pages AD 2.10-1-3 and AD 2.10-1-5

END

Intentionally left blank

**PIARCO INTERNATIONAL NOTAM OFFICE****AIP
SUPPLEMENT**

Tele: 1 868 669-4128
1 868 668-8222 ext 2510
FAX: 1 868 669 1716
AFTN: TTPPYNYX
Email:aimpublication@caa.gov.tt

TRINIDAD & TOBAGO
CIVIL AVIATION AUTHORITY,
P.O. BOX 2163, NATIONAL MAIL CENTRE,
PIARCO
REPUBLIC OF TRINIDAD AND TOBAGO

24/25
15 MAY 25

AD**24. CANEFIELD INTERNATIONAL AIRPORT (TDCF)****PAVEMENT STRENGTH AMENDED****Effective Date: 250515 to PERM**

The pavement strength of the Apron, Taxiway, Runway and Stopway at the Canefield International Airport has been updated to 7138kg.

Please amend Eastern Caribbean AIP pages AD 2.4-1-3 and AD 2.4-1-4

END

Intentionally left blank

**PIARCO INTERNATIONAL NOTAM OFFICE****AIP
SUPPLEMENT**

Tele: 1 868 669-4128
1 868 668-8222 ext 2510
FAX: 1 868 669 1716
AFTN: TTPPYNYX
Email:aimpublication@caa.gov.tt

TRINIDAD & TOBAGO
CIVIL AVIATION AUTHORITY,
P.O. BOX 2163, NATIONAL MAIL CENTRE,
PIARCO
REPUBLIC OF TRINIDAD AND TOBAGO

22/25
06 MAY 25

AD**22. COCO POINT LODGE AIRPORT (TAPT)****CHANGE IN AIRPORT NAME****Effective: 250506 to PERM**

Coco Point Lodge Airport (TAPT) has been changed to Coco Point Airport (TAPT).

Please amend Eastern Caribbean AIP pages GEN 0.6-3, GEN 1.1-1, GEN 1.1-3, GEN 2.4-1, GEN 2.7-1, GEN 2.7-4, GEN 4.1-4, GEN 4.2-2, AD 0.6-2, AD 1.3-1, AD 1.5-1, AD 2.2-1-1

END

Intentionally left blank

**PIARCO INTERNATIONAL NOTAM OFFICE****AIP
SUPPLEMENT**

Tele: 1 868 669-4128
1 868 668-8222 ext 2510
FAX: 1 868 669 1716
AFTN: TTPPYNYX
Email:aimpublication@caa.gov.tt

TRINIDAD & TOBAGO
CIVIL AVIATION AUTHORITY,
P.O. BOX 2163, NATIONAL MAIL CENTRE,
PIARCO
REPUBLIC OF TRINIDAD AND TOBAGO

21/25
05 MAY 25

AD**21. AUGUSTE GEORGE INTERNATIONAL AIRPORT (TUPA)****PRIOR PERMISSION REQUIRED AT AUGUSTE GEORGE INTERNATIONAL AIRPORT****Effective: 250505 to 260505**

Prior permission required (PPR), **twenty-four (24) hours** before the anticipated arrival time for all flights arriving at the Auguste George International Airport. Flights that do not have the required permission to land at the aerodrome shall be denied entry.

All requests must contain the general declaration forms and include the following information:

- Full name;
- Date of birth;
- Nationality;
- Passport number;
- Passport expiry date;
- Additional information, such as the Bio page of passports, is also encouraged.

Requests shall be sent to the following email addresses:

- immintel@gov.vg
- bvicustoms@gov.vg
- ops@bviaa.com

AIP SUP 21/25 replaces NOTAM A0344/25

END

Intentionally left blank

**PIARCO INTERNATIONAL NOTAM OFFICE****AIP
SUPPLEMENT**

Tele: 1 868 669-4128
1 868 668-8222 ext 2510
FAX: 1 868 669 1716
AFTN: TTPPYNYX
Email: aimpublication@caa.gov.tt

TRINIDAD & TOBAGO
CIVIL AVIATION AUTHORITY,
P.O. BOX 2163, NATIONAL MAIL CENTRE,
PIARCO
REPUBLIC OF TRINIDAD AND TOBAGO

19/25
05 MAY 25

AD**19. BARBUDA INTERNATIONAL AIRPORT (TAPB)****AERODROME DATA UPDATED****Effective: 250505 to PERM**

TAPB AD 2.20 Local Traffic Regulations has been amended.

Attachment A contains the updated Aerodrome data for the Barbuda International Airport (TAPB). New information is identified by a change bar symbol located at the left margin where the change has occurred.

AIP SUP 19/25 replaces AIP SUP 28/24

END

Intentionally left blank

ATTACHMENT A

AD 2. AERODROMES

TAPB AD 2.1 AERODROME LOCATION INDICATOR AND NAME

TAPB - BARBUDA/Barbuda - INTL

TAPB AD 2.2 AERODROME GEOGRAPHICAL AND ADMINISTRATIVE DATA

1	ARP coordinates and site at AD	Lat : 173716N Long : 0614754W Site : Intersection of RWY and TWY centre lines
2	Direction and distance from city	1.7NM SE of Codrington city center
3	Elevation/Reference Temperature	8.6M (28FT) / 30.9 °C
4	Geoid Undulation/Location	-42.6M (-139.7FT) / RWY 28 THR
5	MAG VAR/Annual change	15°W (2024) /0° 2' W per year
6	AD Administration, address, telephone, telefax, e-mail	Antigua and Barbuda Airport Authority Chief Executive Officer, V.C. Bird International Airport Coolidge St. George's Antigua and Barbuda TEL: (268) 484-2300, 484-2308 FAX: (268) 484-2340, 484-2346 E-MAIL: info@abairportauthority.com
7	Types of traffic permitted (IFR/VFR)	IFR/VFR
8	Remarks	NIL

TAPB AD 2.3 OPERATIONAL HOURS

1	AD Administration	Refer to AD CEO V.C. Bird International Airport, Antigua
2	Customs and Immigration	1000 - 2200
3	Health and Sanitation	NIL
4	AIS Briefing Office	NIL
5	ATS Reporting Office (ARO)	NIL
6	MET Briefing Office	H24
7	ATS	NIL
8	Fuelling	NIL
9	Handling	1000 - 2200
10	Security	1000 - 2200
11	De-icing	NIL
12	Remarks	Aerodrome operational from sunrise to sunset. Contact agencies at Barbuda International Airport at (268) 484-2399 or boclist@abairportauthority.com to arrange the above services.

TAPB AD 2.4 HANDLING SERVICES AND FACILITIES

1	Cargo-handling facilities	By arrangement with operators
2	Fuel/Oil types	NIL
3	Fuelling facilities/capacity	NIL
4	De-icing	NIL
5	Hangar Space for visiting aircraft	NIL
6	Repair facilities for visiting aircraft	NIL
7	Remarks	Corporate and private operators requiring handling services must proceed to the west apron and request the services of the FBO. See AD 2.20

TAPB AD 2.5 PASSENGER FACILITIES

1	Hotels	Guest Houses
2	Restaurants	In the City
3	Transportation	Taxis, Limousine Service, Car Rentals
4	Medical facilities	First Aid treatment at AD Hospital 3 KM (1.8 NM) from airport
5	Bank and Post Office	In the City. Closed on Public Holidays.
6	Tourist Office	Tourism Office in the city, Tel: (268) 562 -7065/66
7	Remarks	NIL

TAPB AD 2.6 RESCUE AND FIRE FIGHTING SERVICES

1	AD Category for fire fighting	AVAILABLE - Category 5
2	Rescue equipment	1 Ambulance, 1 Pick-up, 1 Tender
3	Capability for removal of disabled aircraft	By arrangements with airlines and local contractor
4	Remarks	NIL

TAPB AD 2.7 SEASONAL AVAILABILITY - CLEARING

1	Types of clearing equipment	NIL
2	Clearance priorities	NIL
3	Remarks	AD available all seasons

TAPB AD 2.8 APRONS, TAXIWAYS AND CHECK LOCATIONS DATA

1	Apron surface and strength	Type of surface: Asphalt Strength: PCR 226/F/B/X/T
2	Taxiway width, surface and strength	TWY A Width: 23 M (75FT) Type of surface: Asphalt Strength: PCR 226/F/B/X/T
3	ACL location and elevation	Location: Location 1 - Apron Stand 1, Elevation 6.7M (22FT) Location 2 - Apron Stand 2, Elevation 7.1M (23FT)
4	VOR Checkpoints	NIL
5	INS Checkpoints	NIL
6	Remarks	NIL

TAPB AD 2.9 SURFACE MOVEMENT GUIDANCE AND CONTROL SYSTEM AND MARKINGS

1	Use of aircraft stand ID signs, TWY guide lines and visual docking/parking guidance system of aircraft stands	Taxiing guidance signs at intersection at holding position, Guidance at Apron.
2	Markings Lights (LGT)	RWY : Designator, THR, TDZ Centre line, End TWY : Centre line, holding positions at TWY/RWY Intersections, Side stripes RWY : THR, Edge, End TWY : Edge
3	Stop bars	NIL
4	Other runways protection measures	NIL
5	Remarks	NIL

TAPB AD 2.10 AERODROME OBSTACLES

ID OBST/ Designation	OBST type	OBST Coordinate	ELEV/HGT	Markings/Type, Colour of Light	Remarks
a	b	c	d	e	f
TAPBOB001	TWR	17 37 31.01N 061 48 26.70W	67.52M (222FT)	lighted red	TWR - New Airport
TAPBOB002	TWR	17 35 22.67N 061 48 58.61W	54.80M (180FT)	lighted red	TWR - Ferry Dock
TAPBOB003	TWR	17 38 26.89N 061 49 32.75W	45.92M (151FT)	lighted red	Cell TWR Codrington

TAPB AD 2.11 METEOROLOGICAL INFORMATION PROVIDED

1	Associated MET Office	V.C. Bird MET Office
2	Hours of service MET Office outside hours	H24
3	Office responsible for TAF preparation Periods of validity	V.C. Bird MET Office
4	Type of landing forecast Interval of issuance	NIL
5	Briefing/consultation provided	NIL
6	Flight documentation Language(s) used	English
7	Charts and other information available for briefing or consultation	NIL
8	Supplementary equipment available for providing information	AWOS 3P 131.875MHZ
9	ATS units provided with information	NIL
10	Additional information (limitation of service, etc.)	NIL

TAPB AD 2.12 RUNWAY PHYSICAL CHARACTERISTICS

Designations RWY NR	TRUE & MAG BRG	Dimensions of RWY (M)	Strength(PCR) and surface of RWY and SWY	THR Coordinates/ RWY End Coordinates THR GUND	THR elevation and highest elevation of TDZ of precision APP RWY	Slope of RWY-SWY
1	2	3	4	5	6	7
10	86.36° GEO 101.36° MAG	1859 x 30	PCR 226/F/B/X/T Asphalt	173713.97N 0614825.18W -42.4M	NA	+0.26%
28	266.36° GEO 281.36° MAG	1859 x 30	PCR 226/F/B/X/T Asphalt	173717.81N 0614722.24W -42.6M	NA	-0.26%

SWY Dimensions (M)	CWY Dimensions (M)	Strip Dimension (M)	RESA Dimensions,	Location/ description of arresting system	OFZ	Remarks
8	9	10	11	12	13	14
NIL	NIL	1979 x 280	92 x 60	NIL	NIL	NIL
NIL	NIL	1979 x 280	92 x 60	NIL	NIL	NIL

TAPB AD 2.13 DECLARED DISTANCES

RWY designator	TORA (M)	TODA (M)	ASDA (M)	LDA (M)	Remarks
1	2	3	4	5	6
10	1859	1859	1859	1859	NIL
28	1859	1859	1859	1859	NIL

TAPB AD 2.14 APPROACH AND RUNWAY LIGHTING

RWY designator	APCH LGT Type LEN INTST	THR LGT Colour WBAR	VASIS (MEHT) PAPI	TDZ, LGT LEN	RWY Centre line LGT, Length, spacing, colour, INTST	RWY edge LGT LEN, spacing colour INTST	RWY End LGT colour WBAR	SWY LGT LEN (M) colour	Remarks
1	2	3	4	5	6	7	8	9	10
10	White High Intensity 900	Green	PAPI L/3° (50.0FT) MEHT	Nil	Nil	1859M 60M white, last 600M yellow	Red	Nil	Nil
28	Nil	Green	PAPI L/3° (50.0FT) MEHT	Nil	Nil	1859M 60M white, last 600M yellow	Red	NIL	Nil

TAPB AD 2.15 OTHER LIGHTING, SECONDARY POWER SUPPLY

1	ABN/IBN location, characteristics and hours of operation	ABN: AD FLG White 24 FPM
2	LDI location and LGT Anemometer location and LGT	LDI: lighted windsock on left side of RWY 10, 100.3M from THR, lighted windsock on left side of RWY 28, 97.8M from THR. ANEMOMETER: remote station on north side of RWY 10, 150M from CL
3	TWY edge and centre lighting	TWY A Edge: Blue, omnidirectional Centre line: NIL
4	Secondary power supply/switch-over time	Secondary Power Supply Switch over time 11.5 Sec
5	Remarks	NIL

IDENT AD 2.20 LOCAL TRAFFIC REGULATIONS

1. Airport regulation

1.1 *Airport Regulations/Restrictions*

1. All traffic landing and departing TAPB must transmit a self-announced broadcast on frequency 122.950MHz.
2. *All aircraft are required to land or depart on the active runway.
3. For arriving aircraft, all engines must be shut down prior to the deplaning of any passenger.
4. For departing aircraft, no engine shall be started until all passengers have boarded the aircraft.
5. All arriving and departing aircraft shall close or activate flight plans immediately on arrival and prior to departure according to the established procedures in TAPB AD 2.22.
6. All corporate, private and commercial aircraft operating into Barbuda International Airport (TAPB) must utilise the services of one of the approved Ground Handling Service Operators.
 - i) Corporate and private aviation (Fixed Based Operator Services) must utilise the services of an FBO
Parking Location: West Apron
Company Name: Dispatch Services Antigua Limited (FBO)
Phone: 1-268-562-4148; 1-268-464-8501/4148
Email: dsa.bbq@dsaltd.info or dsaops@dsaltd.info
 - ii) Commercial aviation must utilise the service of Express Handlers Limited
Parking Location: Commercial Apron
Company Name: Express Handlers Limited
Phone: 1-268-484-1416
Email: expresshandlerslimited@gmail.com
7. All aircraft operating into and out of Barbuda International Airport must have the required permit to operate, issued by the Antigua and Barbuda Air Transport Licensing Board.
Contact: ministry.pucate@gmail.com

**Note 1: The active runway is a runway that other aircraft are using or are intending to use for the purpose of landing or taking off.*

**Note 2: Should it be necessary for an aircraft to land on, or take off from a runway other than the active runway, it is required that the appropriate communication between the pilot and other local traffic takes places to ensure that there are no conflicts.*

2. Taxiing

2.1 Taxiing to and from stands

1. Arriving aircraft will be allocated a Gate Number by the Airport Operations.

IDENT AD 2.21 NOISE ABATEMENT PROCEDURES

NIL

IDENT AD 2.22 FLIGHT PROCEDURES

1. Procedures for IFR/VFR Flights

1.1 General

1. All traffic wishing to operate into Barbuda from outside the V.C. Bird TMA and departing Barbuda for destinations outside the V.C. Bird TMA must file a flight plan with the V.C. Bird AIS via AFTN or email.
2. No flight plan is required for traffic wishing to operate within the V.C Bird TMA. However, information on the flight shall be passed via telephone or on the frequency when airborne.
3. Ascertain by radio on the appropriate TAPB frequency 122.950MHz and by visual observation that no other aircraft or vehicle is likely to be a conflict with the aircraft during take-off.

Maintain a listening watch and follow the reporting procedures as outlined in this document.

2. VFR Traffic

2.1 VFR Arrivals Procedures

1. All arriving VFR traffic must report position, altitude, arrival procedure, intentions and estimated time of arrival prior to entering the area.
 2. Pilots shall make position calls at each of the following points:
 - a. 10 miles away from TAPB
 - b. 5 miles away from TAPB
 - c. 45 degree entry to the downwind
 - d. Downwind
 - e. Base
 - f. Final
 3. The traffic circuit in TAPB shall be flown at 1500ft or below.
 4. *All turns in the circuit shall be to the right for RWY 10 and left-hand circuit for RWY 28.
-

-
5. Aircraft shall approach the traffic circuit from the downwind side. However, if the pilot has positively determined that either there is no other traffic or that there will be no conflicting circuit traffic, aircraft shall join via crosswind for RWY 10 and base leg for RWY 28.
 6. When joining the downwind, descend to cross abeam the threshold of the active runway in level flight at the published circuit altitude of 1500ft. Maintain that altitude until further descent is required for landing.
 7. All descents should be made on the downwind side or well clear of the circuit pattern.

**Note 1: NO UPWIND due to the BIRD SANCTUARY to the north of the airfield.*

2.2 VFR Departures

1. All VFR aircraft departing RWY 10 should climb on the runway heading until above 2000ft before commencing a right turn to an enroute heading. Departures wishing to make a left turn shall maintain runway heading until above 5000ft. Turns back toward the circuit or airport should not be initiated until the aircraft is at 2000ft or higher.
2. For aircraft departing RWY 28 right turns are prohibited to avoid the bird sanctuary.

3. IFR Traffic

3.1 IFR Departures

1. Options for all departures requesting IFR:
 - a. Primary Option: Call on the ground in TAPB and request an IFR clearance with an ETD. This may be done via telephone or via a radio frequency. The controller shall issue an IFR clearance with a clearance expiry time.
 - b. Report your intentions on the appropriate discrete TAPB frequency 122.950MHz before moving on to the active runway.

Please note it might take some time due to coordination procedures or airspace congestion, before the pilot can receive an IFR clearance.

3.2 IFR Arrivals

1. All arriving IFR aircraft inbound to TAPB must continue on their current flight plan to the ANU VOR with clearance to proceed outbound on R005 ANU at 2500ft with clearance limit 20DME, then cancel IFR and descend to 2000ft into class G airspace. The aircraft shall proceed to join the traffic circuit at TAPB and follow the procedure for VFR arrivals (see section 2.1) into TAPB.
 2. All arriving aircraft, IFR or VFR, shall close their flight plan once they have landed via the assigned frequency or designated phone line.
-

IDENT AD 2.23 ADDITIONAL INFORMATION

1. Bird concentrations in the vicinity of the airport

A frigatebird sanctuary is located in the northern part of the island. Occasionally, frigatebirds may be seen anywhere over the Barbuda Airport or offshore. Pilots are asked to remain vigilant.

IDENT AD 2.24 CHARTS RELATED TO AERODROME

1. Aerodrome/Heliport Chart AD2.2-3-13
2. Aerodrome Obstacle Chart – ICAO Type A RWY 10/28 AD2.2-3-15

IDENT AD 2.25 Visual Segment Surface (VSS)

Procedure	Procedure Minima	VSS Penetration
1	2	3
-	-	-

**PIARCO INTERNATIONAL NOTAM OFFICE****AIP
SUPPLEMENT**

Tele: 1 868 669-4128
1 868 668-8222 ext 2510
FAX: 1 868 669 1716
AFTN: TTPPYNYX
Email:aimpublication@caa.gov.tt

TRINIDAD & TOBAGO
CIVIL AVIATION AUTHORITY,
P.O. BOX 2163, NATIONAL MAIL CENTRE,
PIARCO
REPUBLIC OF TRINIDAD AND TOBAGO

18/25
30 APR 25

ENR**18. V.C. BIRD INTERNATIONAL AIRPORT (TAPA)****AMENDMENTS TO AIR NAVIGATION OBSTACLES****Effective: 250430 to PERM**

The following amendments have been made to Antigua's air navigation obstacles - Area 1:

- Removal of Codrington - Antenna Tower;
- Addition of TWR – New Airport.

See updated table for Antigua's Air Navigation Obstacles below for your reference.

Designation	Type of Obstacle	Coordinates	HEIGHT IN FEET		OBST LGT & Type/Colour
			AGL	AMSL	
ANTIGUA					
-	Antenna	17 08 37N 061 48 15W	-	316	Lighted
Friars Hill	Transmission Tower	17 08 55N 061 49 50W*	200	550	Lighted
Mc Nish Mountain	Antenna	17 03 30N 061 50 32W	250	1370	Lighted
Mt Pleasant	Tower	17 08 55N 061 48 57W BRG 334 DEG. MAG. 1.3NM from THR RWY07	-	590	Lighted
TWR - New Airport	Antenna Tower	17 37 31N 061 48 27W	-	222	Red strobe light

Please amend Eastern Caribbean AIP page ENR 5.4-1

END

Intentionally left blank

**PIARCO INTERNATIONAL NOTAM OFFICE****AIP
SUPPLEMENT**

Tele: 1 868 669-4128
1 868 668-8222 ext 2510
FAX: 1 868 669 1716
AFTN: TTPPYNYX
Email: aimpublication@caa.gov.tt

TRINIDAD & TOBAGO
CIVIL AVIATION AUTHORITY,
P.O. BOX 2163, NATIONAL MAIL CENTRE,
PIARCO
REPUBLIC OF TRINIDAD AND TOBAGO

17/25
30 APR 25

ENR**17. PIARCO FIR (TTZP)****AMENDMENTS TO A555 ROUTE****Effective: 250430 to PERM**

The bearings of the following segments on the A555 route have been amended as follows:

KELSO-BGI 334°
 154°

BGI-BORUS 330°
 150°

Please amend Eastern Caribbean AIP page ENR 3.1 A555-1

END

Intentionally left blank



PIARCO INTERNATIONAL NOTAM OFFICE

AIP SUPPLEMENT

Tele: 1 868 669-4128
1 868 668-8222 ext 2510
FAX: 1 868 669 1716
AFTN: TTPPYNYX
Email:aimpublication@caa.gov.tt

TRINIDAD & TOBAGO
CIVIL AVIATION AUTHORITY,
P.O. BOX 2163, NATIONAL MAIL CENTRE,
PIARCO
REPUBLIC OF TRINIDAD AND TOBAGO

16/25
28 APR 25

GEN

16. ROBERT L. BRADSHAW INTERNATIONAL AIRPORT (TKPK)

SEARCH AND RESCUE SERVICES

Effective: 250428 to PERM

The Search and Rescue Services at Robert L. Bradshaw International Airport, have been updated as follows:

The St. Kitts and Nevis Defence Force Coast Guard (SKNDF-CG) is responsible for providing Search and Rescue (SAR) services to vessels in distress within the territorial waters of St. Kitts and Nevis. Additionally, we offer SAR assistance in neighbouring or international waters upon request from neighbouring islands. At present, the SKNDF-CG operates solely with sea-going maritime assets. However, the Maritime Coordination Centre (MRCC) Fort De France, which oversees the Search and Rescue Region (SRR) that includes St. Kitts, provides aerial support as needed. This aerial assistance is typically rendered by either the French or Dutch Caribbean Coast Guard, based on the specific requirements of the situation. The Coast Guard Base maintains vigilance by monitoring marine VHF frequencies ranging from 121.500MHz to 156.000MHz and extending up to 162.500MHz. In addition to these capabilities, the SKNDF-CG coordinates with local salvage and towing companies for operational support. For salvage operations, we collaborate with St. Kitts Marine Works Ltd, and for towing operations, we enlist the services of Marine Assist when the tow limit of our assets are surpassed. This comprehensive approach ensures effective management of maritime emergencies and coordination with both national and regional resources.

ST. KITTS & NEVIS COAST GUARD	BASSETERRE 17 17.39N 062 42.39W	TWO SAFE BOATS	Speed 44kts 21 persons each Operational Range 300NM VHF CH 16 VHF 121.500MHz
		ONE 40FT PATROL BOAT	Speed 35kts 25 persons Operational Range 500NM VHF CH 16 VHF 121.500MHz
		ONE 920 ZODIAC RHIB	Speed 40kts 7 persons Operational Range 250NM VHF CH 16 VHF 121.500MHz

Please amend Eastern Caribbean AIP pages GEN 3.6-2 and GEN 3.6-4

END

Intentionally left blank

**PIARCO INTERNATIONAL NOTAM OFFICE****AIP
SUPPLEMENT**

Tele: 1 868 669-4128
1 868 668-8222 ext 2510
FAX: 1 868 669 1716
AFTN: TTPPYNYX
Email:aimpublication@caa.gov.tt

TRINIDAD & TOBAGO
CIVIL AVIATION AUTHORITY,
P.O. BOX 2163, NATIONAL MAIL CENTRE,
PIARCO
REPUBLIC OF TRINIDAD AND TOBAGO

15/25
28 APR 25

AD**15. CLAYTON J. LLOYD INTERNATIONAL AIRPORT (TQPF)****RESCUE AND FIRE FIGHTING SERVICES****Effective: 250428 to PERM**

The rescue and fire fighting services at Clayton J. Lloyd International Airport, have been updated as follows:

1	AD Category for fire fighting	Category 6
2	Rescue equipment (Appliances)	Three Rosenbauer fire tenders: Rosenbauer Panther-R5 Rosenbauer Panther HRET-R6 Rosenbauer Panther-R7
3	Capability for removal of disabled aircraft	Cranes and jacks available from private companies, capable of lifting aircraft up to a maximum AUW 18,000kg
4	Remarks	Marine rescue assistance available from San Juan RCC, Dutch and French Marine Rescue. Rescue and fire fighting coverage at Category 7 on request.

Please amend Eastern Caribbean AIP page AD 2.1-1-2

END

Intentionally left blank

**PIARCO INTERNATIONAL NOTAM OFFICE****AIP
SUPPLEMENT**

Tele: 1 868 669-4128
1 868 668-8222 ext 2510
FAX: 1 868 669 1716
AFTN: TTPPYNYX
Email:aimpublication@caa.gov.tt

TRINIDAD & TOBAGO
CIVIL AVIATION AUTHORITY,
P.O. BOX 2163, NATIONAL MAIL CENTRE,
PIARCO
REPUBLIC OF TRINIDAD AND TOBAGO

14/25
25 APR 25

GEN**14. MAURICE BISHOP INTERNATIONAL AIRPORT (TGPY)****SEARCH AND RESCUE SERVICES****Effective: 250425 to PERM**

The Search and Rescue Services at St. Georges Grenada, have been updated as follows:

GRENADA COAST GUARD	PRICKLEY BAY ST. GEORGES 12 01.00N 061 44.20W	ONE 45FT OFFSHORE PATROL VESSEL (OPV)	Speed 35kts 30 persons Operational Range 400NM VHF CH 16
		ONE 40FT OFFSHORE PATROL VESSEL (OPV)	Speed 28kts 25 persons Operational Range 400NM VHF CH 16
		TWO 33FT INTERCEPTORS	Speed 45kts 12 persons each Operational Range 150NM VHF CH 16

Please amend Eastern Caribbean AIP page GEN 3.6-4

END

Intentionally left blank

**PIARCO INTERNATIONAL NOTAM OFFICE****AIP
SUPPLEMENT**

Tele: 1 868 669-4128
1 868 668-8222 ext 2510
FAX: 1 868 669 1716
AFTN: TTPPYNYX
Email:aimpublication@caa.gov.tt

TRINIDAD & TOBAGO
CIVIL AVIATION AUTHORITY,
P.O. BOX 2163, NATIONAL MAIL CENTRE,
PIARCO
REPUBLIC OF TRINIDAD AND TOBAGO

13/25
25 APR 25

AD**13. BRITISH VIRGIN ISLANDS****SAFETY REPORTING FOR AUGUSTE GEORGE AIRPORT (TUPA), TERRANCE B. LETTSOME INTERNATIONAL AIRPORT (TUPJ) AND VIRGIN GORDA AIRPORT (TUPW)****Effective: 250425 to PERM**

All pilots and aircraft operators can file reports in accordance with OTAC-13 through the website:
<https://www.airsafety.aero/safety-information-and-reporting/report>

END

Intentionally left blank

**PIARCO INTERNATIONAL NOTAM OFFICE****AIP
SUPPLEMENT**

Tele: 1 868 669-4128
1 868 668-8222 ext 2510
FAX: 1 868 669 1716
AFTN: TTPPYNYX
Email:aimpublication@caa.gov.tt

TRINIDAD & TOBAGO
CIVIL AVIATION AUTHORITY,
P.O. BOX 2163, NATIONAL MAIL CENTRE,
PIARCO
REPUBLIC OF TRINIDAD AND TOBAGO

12/25
24 APR 25

AD**12. TERRANCE B. LETTSOME INTERNATIONAL AIRPORT (TUPJ)****GROUND HANDLING SERVICES REQUIREMENT****Effective: 250424 to PERM**

All flights arriving/departing Terrance B. Lettsome International Airport, are required to have ground handling services. The ground handling companies listed below are available at the aerodrome.

1. Airport Services BVI
Website: www.asbvi.com
Email: operations@asbvi.com
Phone: 284-542-9400
Frequency: 131.000MHz
2. Platinum Services BVI
Website: www.platinumbviservices.com
Email: platinumbviservices@romascogroup.com
Phone: 284-495-1298
3. IAM Jet Centre
Website: www.iamjetcentre.com
Email: eisops@iamjetcentre.com
Phone: 284-495-0303
4. VI Airlink General Aviation
Email: info@viairlink.com
Phone: 284-346-2134

END

Intentionally left blank

**PIARCO INTERNATIONAL NOTAM OFFICE****AIP
SUPPLEMENT**

Tele: 1 868 669-4128
1 868 668-8222 ext 2510
FAX: 1 868 669 1716
AFTN: TTPPYNYX
Email:aimpublication@caa.gov.tt

TRINIDAD & TOBAGO
CIVIL AVIATION AUTHORITY,
P.O. BOX 2163, NATIONAL MAIL CENTRE,
PIARCO
REPUBLIC OF TRINIDAD AND TOBAGO

11/25
24 APR 25

AD**11. TERRANCE B. LETTSOME (TUPJ)****AMENDMENTS TO THE PHRASEOLOGY OF THE DEPARTURE INSTRUCTIONS AT THE TERRANCE B. LETTSOME INTERNATIONAL AIRPORT****Effective: 250424 to PERM**

The amended phraseology to the departure instructions shall apply to all flights which have filed IFR Flight Plans departing the Terrance B. Lettsome International Airport:

1. "Fly the Lettsome Departure," in lieu of: 'Fly Runway heading until reaching 1000FT then turn left heading 330°.'
2. "Fly the Franklin Departure," in lieu of: 'Fly Runway heading until reaching 1000FT then turn right heading 180°.'
3. "Fly the Gateway Departure," in lieu of: 'Early left turn heading 180°.'

The following are the departure instructions with the amended phraseology:

SAN JUAN or ISLA GRANDE RWY 07

Fly the Lettsome Departure (Runway heading until reaching 1000FT then turn left heading 330°) until reaching 3200FT, then via STT-RTE6-CHAKA-SNGRA-REKUA-SJU. Maintain 4000FT, expect requested altitude ten (10) minutes after departure. Departure Control Frequency: 132.250MHz or 128.650MHz.

SAN JUAN or ISLA GRANDE RWY 25

Fly the Gateway Departure (Early left turn heading 180°) until reaching 3200FT then via STT-RTE6-CHAKA-SNGRA-REKUA-SJU. Maintain 4000FT, expect requested altitude ten (10) minutes after departure. Departure Control Frequency: 132.250MHz or 128.650MHz.

ST MAARTEN RWY 07

Fly the Franklin Departure (Runway heading until reaching 1000FT then turn right heading 180°). Expect Radar vectors to join A638-PJM-TNCM. Maintain 4000FT, expect requested altitude ten (10) minutes after departure. Departure Control Frequency: 132.250MHz or 128.650MHz.

ST MAARTEN RWY 25

Fly the Gateway Departure (Early left turn heading 180°). Expect Radar vectors to join A638-PJM-TNCM. Maintain 4000FT, expect requested altitude ten (10) minutes after departure. Departure Control Frequency: 132.250MHz or 128.650MHz.

ST KITTS or ANTIGUA (FILED BELOW FL160) RWY 07

Fly the Franklin Departure (Runway heading until reaching 1000FT then turn right heading 180°). Expect Radar vectors to join G633-SKB. Maintain 4000FT, expect requested altitude ten (10) minutes after departure. Departure Control Frequency: 132.250MHz or 128.650MHz.

ST KITTS or ANTIGUA (FILED BELOW FL160) RWY 25

Fly the Gateway Departure (Early left turn heading 180°). Expect Radar vectors to join G633-SKB. Maintain 4000FT, expect requested altitude ten (10) minutes after departure. Departure Control Frequency: 132.250MHz or 128.650MHz.

ANTIGUA (FILED FL160 or ABOVE) RWY 07

Fly the Franklin Departure (Runway heading until reaching 1000FT then turn right heading 180°). Expect Radar vectors to join B520-PJM-A517-SKB. Maintain 4000FT, expect requested altitude ten (10) minutes after departure. Departure Control Frequency: 132.250MHz or 128.650MHz.

ANTIGUA (FILED FL160 OR ABOVE) RWY 25

Fly the Gateway Departure (Early left turn heading 180°). Expect Radar vectors to join B520-PJM-A517-SKB. Maintain 4000FT, expect requested altitude ten (10) minutes after departure. Departure Control Frequency: 132.250MHz or 128.650MHz.

AIP SUP 11/25 revises AIP SUP 17/24

END

**PIARCO INTERNATIONAL NOTAM OFFICE****AIP
SUPPLEMENT**

Tele: 1 868 669-4128
1 868 668-8222 ext 2510
FAX: 1 868 669 1716
AFTN: TTPPYNYX
Email:aimpublication@caa.gov.tt

TRINIDAD & TOBAGO
CIVIL AVIATION AUTHORITY,
P.O. BOX 2163, NATIONAL MAIL CENTRE,
PIARCO
REPUBLIC OF TRINIDAD AND TOBAGO

09/25
23 APR 25

AD**09. ROBERT L. BRADSHAW INTERNATIONAL AIRPORT (TKPK)****AIRSPACE CLASSIFICATION AMENDED****Effective: 250423 to PERM**

In order to align the airspace with the services that are being provided at the Robert L. Bradshaw International Airport, the airspace classification has been upgraded to Class D.

Please amend Eastern Caribbean AIP pages AD 2.7-1-7, ENR 2.2-6, ENR 2.2-11

END

Intentionally left blank

**PIARCO INTERNATIONAL NOTAM OFFICE****AIP
SUPPLEMENT**

Tele: 1 868 669-4128
1 868 668-8222 ext 2510
FAX: 1 868 669 1716
AFTN: TTPPYNYX
Email:aimpublication@caa.gov.tt

TRINIDAD & TOBAGO
CIVIL AVIATION AUTHORITY,
P.O. BOX 2163, NATIONAL MAIL CENTRE,
PIARCO
REPUBLIC OF TRINIDAD AND TOBAGO

07/25
16 APR 25

AD**07. JOHN A. OSBORNE INTERNATIONAL AIRPORT (TRPG)****AIRPORT RESTRICTION AT JOHN A. OSBORNE INTERNATIONAL AIRPORT****Effective: 250416 to 260416**

By the United Kingdom Department for Transport:

No aircraft which is owned, chartered or operated by a person connected with Russia, or which is registered in Russia shall fly in Montserrat's airspace, including in the airspace above the territorial sea. This regulation does not apply to any aircraft flying in accordance with the permission of the UK Secretary of State for Transport.

Permissions available from Air Safety Support International (ASSI) at **enquiries@airsafety.aero**

END

Intentionally left blank



PIARCO INTERNATIONAL NOTAM OFFICE

AIP SUPPLEMENT

Tele: 1 868 669-4128
1 868 668-8222 ext 2510
FAX: 1 868 669 1716
AFTN: TTPPYNYX
Email:aimpublication@caa.gov.tt

TRINIDAD & TOBAGO
CIVIL AVIATION AUTHORITY,
P.O. BOX 2163, NATIONAL MAIL CENTRE,
PIARCO
REPUBLIC OF TRINIDAD AND TOBAGO

06/25
04 APR 25

AD

06. PIARCO INTERNATIONAL AIRPORT (TTPP) AND A.N.R. ROBINSON INTERNATIONAL AIRPORT (TTCP)

INCLUSION OF AERODROME OBSTACLES

Effective: 250404 to PERM

Additional aerodrome obstacles in Area 2 have been included for the Piarco International Airport (TTPP) and the A.N.R. Robinson International Airport (TTCP) as follows:

Piarco International Airport (TTPP)

ID OBST/ Designation	OBST Type	OBST Coordinate	ELEV/HGT	Markings/Type, Colour of Light	Remarks
a	b	c	d	e	f
TTPPOB006	Building	10 35 48.8N 061 21 00.7W	14M (47FT)/5M (17FT)	LGTD	
TTPPOB007	Approach Lights	10 35 43.2N 061 21 17.4W	8M (26FT)/5M (18FT)	Yellow markings/ White light	
TTPPOB008	Approach Lights	10 35 43.0N 061 21 16.3W	8M (25FT)/6M (18FT)	Yellow markings/ White light	
TTPPOB009	Approach Lights	10 35 43.1N 061 21 15.4W	13M (42FT)/5M (16FT)	Yellow markings/ White light	
TTPPOB010	Blast Fence	10 35 46.7N 061 21 13.4W	11M (35FT)/5M (16FT)	NIL	
TTPPOB011	Building	10 35 48.3N 061 21 12.8W	11M (38FT)/4M (14FT)	LGTD	
TTPPOB012	Building	10 35 48.3N 061 21 12.3W	12M (40FT)/4M (14FT)	LGTD	
TTPPOB013	Building	10 35 48.7N 061 21 00.1W	14M (47FT)/4M (14FT)	LGTD	
TTPPOB014	Building	10 35 48.8N 061 20 54.1W	15M (50FT)/6M (20FT)	LGTD	
TTPPOB015	Antenna	10 35 48.3N 061 20 48.9W	15M (51FT)/5M (16FT)	Red & white markings/LGTD	
TTPPOB016	Building	10 35 48.9N 061 21 09.9W	20M (66FT)/12M (39FT)	LGTD	
TTPPOB017	Building	10 35 48.9N 061 21 11.7W	18M (58FT)/9M (31FT)	LGTD	
TTPPOB018	Building	10 35 48.8N 061 21 09.9W	20M (66FT)	LGTD	HGT unavailable
TTPPOB019	Antenna	10 35 50.0N 061 21 08.3W	28M (91FT)	Red & white markings/Red light	HGT unavailable
TTPPOB020	Building	10 35 49.0N 061 21 07.0W	31M (100FT)	LGTD	HGT unavailable
TTPPOB021	Antenna	10 35 36.9N 061 19 27.4W	28M (91FT)/11M (36FT)	Red & white markings/Red light	

A.N.R. Robinson International Airport (TTCP)

ID OBST/ Designation	OBST Type	OBST Coordinate	ELEV/HGT	Markings/Type, Colour of Light	Remarks
a	b	c	d	e	f
TTCPOB003	Building	11 09 05.5N 060 50 38.8W	15M (48FT)/8M (26FT)	LGTD	
TTCPOB004	Building	11 09 05.3N 060 50 36.1W	12M (40FT)/4M (13FT)	LGTD	
TTCPOB005	General Utility	11 09 06.0N 060 50 35.4W	18M (60FT)/11M (36FT)	LGTD	
TTCPOB006	General Utility	11 08 58.2N 060 50 33.5W	19M (63FT)/11M (35FT)	LGTD	
TTCPOB007	General Utility	11 08 58.7N 060 50 39.0W	23M (75FT)/15M (50FT)	LGTD	
TTCPOB008	General Utility	11 08 58.6N 060 50 37.3W	22M (72FT)/13M (44FT)	LGTD	
TTCPOB009	General Utility	11 08 58.4N 060 50 35.6W	21M (70FT)/12M (41FT)	LGTD	
TTCPOB010	Building	11 09 04.9N 060 50 35.0W	12M (39FT)/8M (26FT)	LGTD	
TTCPOB011	Antenna	11 08 53.1N 060 50 39.8W	33M (109FT)	Red & white markings/ Red light	HGT unavailable

Please amend the Eastern Caribbean AIP pages AD 2.10-1-4 and AD 2.10-2-4

END



PIARCO INTERNATIONAL NOTAM OFFICE

**AIP
SUPPLEMENT**

Tele: 1 868 669-4128
1 868 668-8222 ext 2510
FAX: 1 868 669 1716
AFTN: TTPPYNYX
Email:aimpublication@caa.gov.tt

TRINIDAD & TOBAGO
CIVIL AVIATION AUTHORITY,
P.O. BOX 2163, NATIONAL MAIL
CENTRE, PIARCO
REPUBLIC OF TRINIDAD AND TOBAGO

**04/25
24 JAN 25**

GEN

04. V.C. BIRD INTERNATIONAL AIRPORT (TAPA)

METEOROLOGICAL SERVICES AMENDED

Effective: 250124 to PERM

The information for the responsible service and meteorological observations and reports for Antigua and Barbuda Meteorological Services have been amended.

- Email address for the responsible service has been updated to **metoffice@ab.gov.ag**

- GEN 3.5.3 Meteorological observations and reports:

Column 2 *Type and Frequency of observation/automatic observing equipment*, has been updated to **Hourly, Special/Automatic Weather Observing Station (AWOS)**

Column 4 *Observation System and Sites*, has been updated to **Automatic Weather Observing Station (AWOS) providing air temperatures, surface wind and variation (direction and speed) and rainfall values.**

Please amend the Eastern Caribbean AIP pages GEN 3.5-1 and GEN 3.5-4

END

Intentionally left blank

**PIARCO INTERNATIONAL NOTAM OFFICE****AIRAC
AIP
SUPPLEMENT**

Tele: 1 868 669-4128
1 868 668-8222 ext 2510
FAX: 1 868 669 1716
AFTN: TTPPYNYX
Email:aimpublication@caa.gov.tt

TRINIDAD & TOBAGO
CIVIL AVIATION AUTHORITY,
P.O. BOX 2163, NATIONAL MAIL CENTRE,
PIARCO
REPUBLIC OF TRINIDAD AND TOBAGO

03/25
22 JAN 25

AD**03. DOUGLAS CHARLES INTERNATIONAL AIRPORT (TDPD)****VERTICAL LIMITS OF THE AIR TRAFFIC SERVICES AIRSPACE AND AIRSPACE CLASSIFICATION
AMENDED****Effective: 250220 to PERM**

The Air Traffic Services Airspace and Classification along with other aerodrome information at the Douglas Charles International Airport, have been amended.

The following data pages and charts have been amended:

- Attachment A - **Changes to Aerodrome and Enroute data**
- Attachment B - **KAROT ONE RNAV (GNSS) DEP**
- Attachment C – **RNAV GNSS Y RWY 27**
- Attachment D – **RNAV GNSS Z RWY 27**
- Attachment E - **NDB RWY 27**

END

Intentionally left blank

ATTACHMENT A

The information for the Douglas International Airport in bold font within the Aerodrome and Enroute tables below contain the changes for each subsection:

TDPD AD 2.6 RESCUE AND FIRE FIGHTING SERVICES

2	Rescue equipment	NIL
----------	-------------------------	------------

TDPD AD 2.12 RUNWAY PHYSICAL CHARACTERISTICS

Designations RWY NR	TRUE & MAG BRG	Dimension of RWY (M)	Strength (PCR) and surface of RWY and SWY	THR Coordinates/ RWY End Coordinates THR GUND	THR elevation and highest elevation of TDZ of precision APP RWY	Slope of RWY/ SWY
1	2	3	4	5	6	7
09	070° GEO 085° MAG	1936 x 45	PCN 71/F/A/X/T Asphalt/Nil	153235.82N 0611838.56W	THR 22.10 m (72.51 ft)	NIL
27	250° GEO 265° MAG	1936 x 45	PCN 71/F/A/X/T Asphalt/Nil	153257.42N 0611737.52W	THR 5.00 m (16.40 ft)	NIL
8	9	10	11	12	13	14
SWY Dimensions (M)	CWY Dimensions (M)	Strip Dimensions (M)	RESA Dimensions	Location/ Description of Arresting System	OFZ	Remarks
NIL	790 x 150	1928 x 150	90x90	NIL	NIL	RWY Surface Grooved THR RWY 09 displaced 405M (N153241.78 W0611821.74) ELEV 21.64m (71ft)
NIL	NIL	1928 x 150	90x90	NIL	NIL	RWY Surface Grooved

ATTACHMENT A

TDCF AD 2.17 ATS AIRSPACE

2	Vertical limits	SFC/3000 FT AAL
3	Airspace classification	D
5	Transition altitude	9000 FT

TDPD AD 2.22 FLIGHT PROCEDURES

1 Procedures for IFR flights

1.2 APPROACHES

1.2.1 All aircraft intending to land at Douglas-Charles Airport will be cleared for the RNAV, NDB/DME or visual approach by Le Raizet Approach Tower.

ATC procedure shall, however severely restrict/prohibit departures from Douglas Charles during IFR approach operations, due to the reciprocal track situation published on the IFR procedure track.

1.2.6 The following are the ATC procedures for the conduct of: NDB (DME) and RNAV/GNSS approaches at Douglas Charles.

a) NDB (DME) Approaches

Pilots of IFR aircraft landing at Douglas Charles, Dominica, will be cleared by Le Raizet APP or Fort de France APP to proceed to IAF NOSAM in order to conduct an NDB RWY27 approach procedure. Pilots may request to proceed to IAF SEDOG or ULOMA either prior to reaching FOF or PPR or before departing TFFF or TFFR.

b) RNAV/GNSS Approaches

Pilots of IFR aircraft landing at Douglas Charles, Dominica, who intend to conduct an RNAV/GNSS RWY 27 procedure, shall advise Le Raizet APP or Fort de France APP either prior to reaching FOF or PPR or before departing TFFF or TFFR. The pilot shall inform Le Raizet APP or Fort de France APP of the appropriate IAF (ADVUR, VOLAB or IGROP) to which they request to be cleared. Le Raizet APP will provide clearance for the aircraft to conduct said approach procedure.

1.2.7 In the event of failure of the NDB or DME at Douglas Charles; for IFR aircraft that are not able to conduct the RNAV (GNSS) RWY 27 Approach, Le Raizet RAPCO will provide an ATC clearance to fly NOSAM (the default IAF), either by the aircraft's own navigation or by providing Radar-vectoring, and to descend to 3000 FT QNH. Below this altitude, the pilot may continue IFR on a visual approach or the pilot may cancel IFR flight and continue VFR.

ATTACHMENT A

The Aeronautical Data page of the following departure procedure has been amended to incorporate THR RWY 09 elevation 71' (ft):

AD 2.4-2-18 KAROT ONE RNAV (GNSS) DEP – Attachment B

The following INSTRUMENT APPROACH CHART – ICAO have been amended:

AD 2.4-2-21 RNAV GNSS Y RWY 27 – Attachment C

AD 2.4-2-23 RNAV GNSS Z RWY 27 – Attachment D

AD 2.4-2-25 NDB RWY 27 – Attachment E

The following are changes to the ENR 2.2 page for the change in Vertical Limits and Airspace Classification:

Name Lateral limits Vertical limits Class of airspace	Units providing service	Call sign Languages Area and conditions of use Hours of service	Frequency/ Purpose	Remarks
1	2	3	4	5
DOUGLAS CHARLES AERODROME TRAFFIC ZONE (ATZ) (Dominica) Circular area centered on 153248N/ 0611805W (ARP) within a 2NM radius. 3000FT AAL SFC CLASS of Airspace: D				

Intentionally left blank

ATTACHMENT B

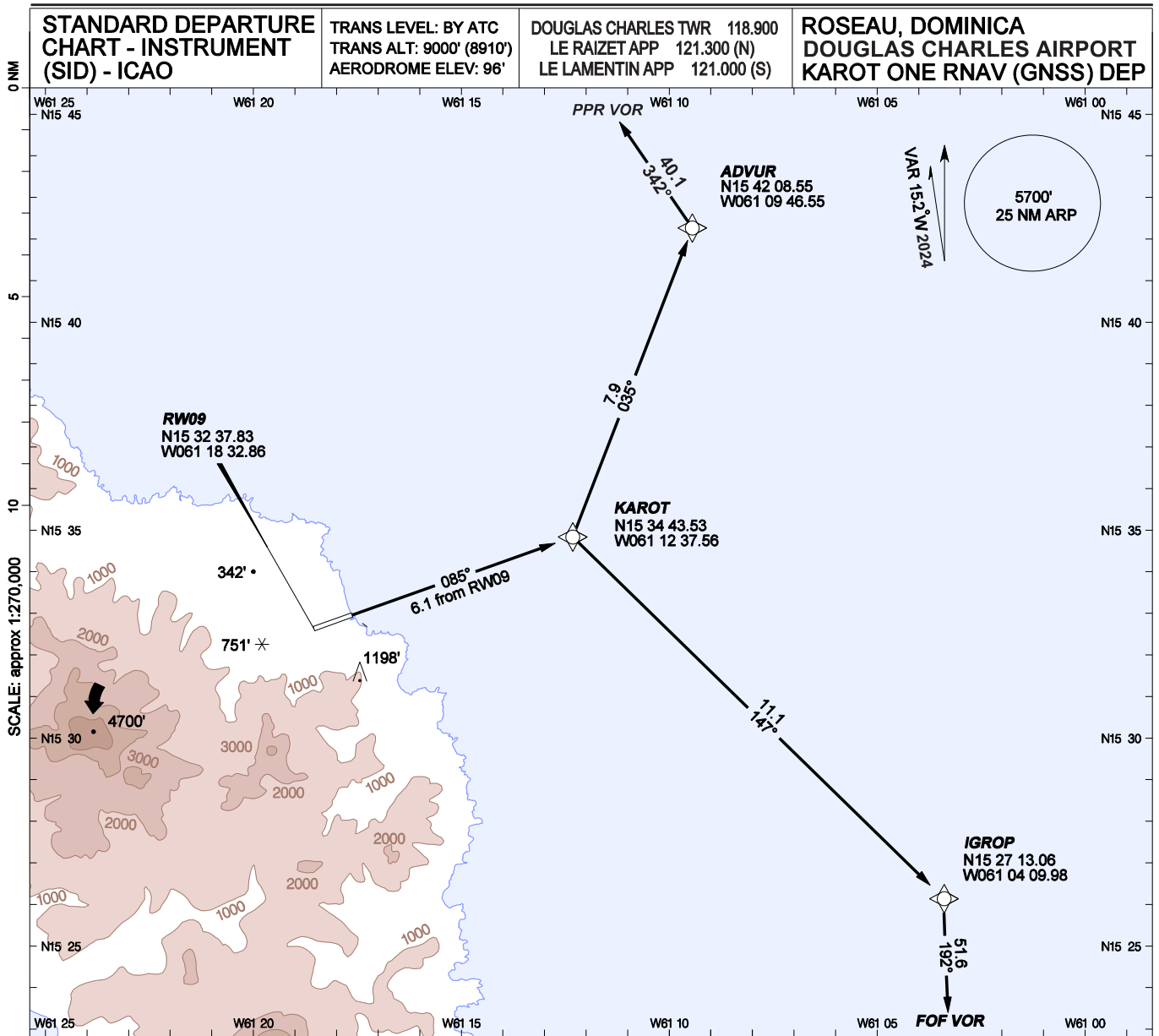

INITIAL CLIMB	
Climb on track 085° to KAROT.	
VIA	ROUTING
PPR VOR	Turn left via track 035° to ADVUR, then turn left via track 342° to PPR VOR
FOF VOR	Turn right via track 147° to IGROP, then turn right via track 192° to FOF VOR

Bearings are magnetic, altitudes and elevation in feet, heights are relative to AD elevation, distance in NM.

Fly-by on demand reporting waypoint

TDPD KAROT ONE RNAV (GNSS) DEPARTURE AERONAUTICAL DATA

FIX DATA

<i>Type Fix</i>	<i>Fix Name</i>	<i>Fix Coordinates</i>	
Enroute	PPR VOR	N16 15 54.70 W061 32 24.50	
Enroute	FOF VOR	N14 35 26.69 W061 01 22.11	
SID	KAROT	N15 34 43.53 W061 12 37.56	
SID	ADVUR	N15 42 08.55 W061 09 46.55	
SID	IGROP	N15 27 13.06 W061 04 09.98	
Runway	RW09	N15 32 37.83 W061 18 32.86	

SEGMENT DATA

<i>From</i>	<i>To</i>	<i>Distance</i>	<i>Magnetic Bearing</i>
RW09	KAROT	6.09 NM	084.94
KAROT	ADVUR	7.88 NM	035.42
ADVUR	PPR VOR	40.08 NM	342.00
KAROT	IGROP	11.07 NM	147.45
IGROP	FOF VOR	51.62 NM	191.99

OTHER DATA

- Aerodrome elevation: 96'
- THR RWY 09 elevation: 71'
- THR RWY 27 elevation: 16'
- Magnetic variation used: 15.2 W

ATTACHMENT C

**INSTRUMENT
APPROACH
CHART - ICAO**

AERODROME ELEV 96 FT
OCH RELATED TO THRE
OTHER HEIGHTS RELATED TO AD ELEV

DOUGLAS CHARLES TWR 118.900
LE RAIZET APP 121.300 (N)
LE LAMENTIN APP 121.000 (S)

**ROSEAU, DOMINICA
DOUGLAS CHARLES APT (TDPD)
RNAV (GNSS) Y RWY 27**

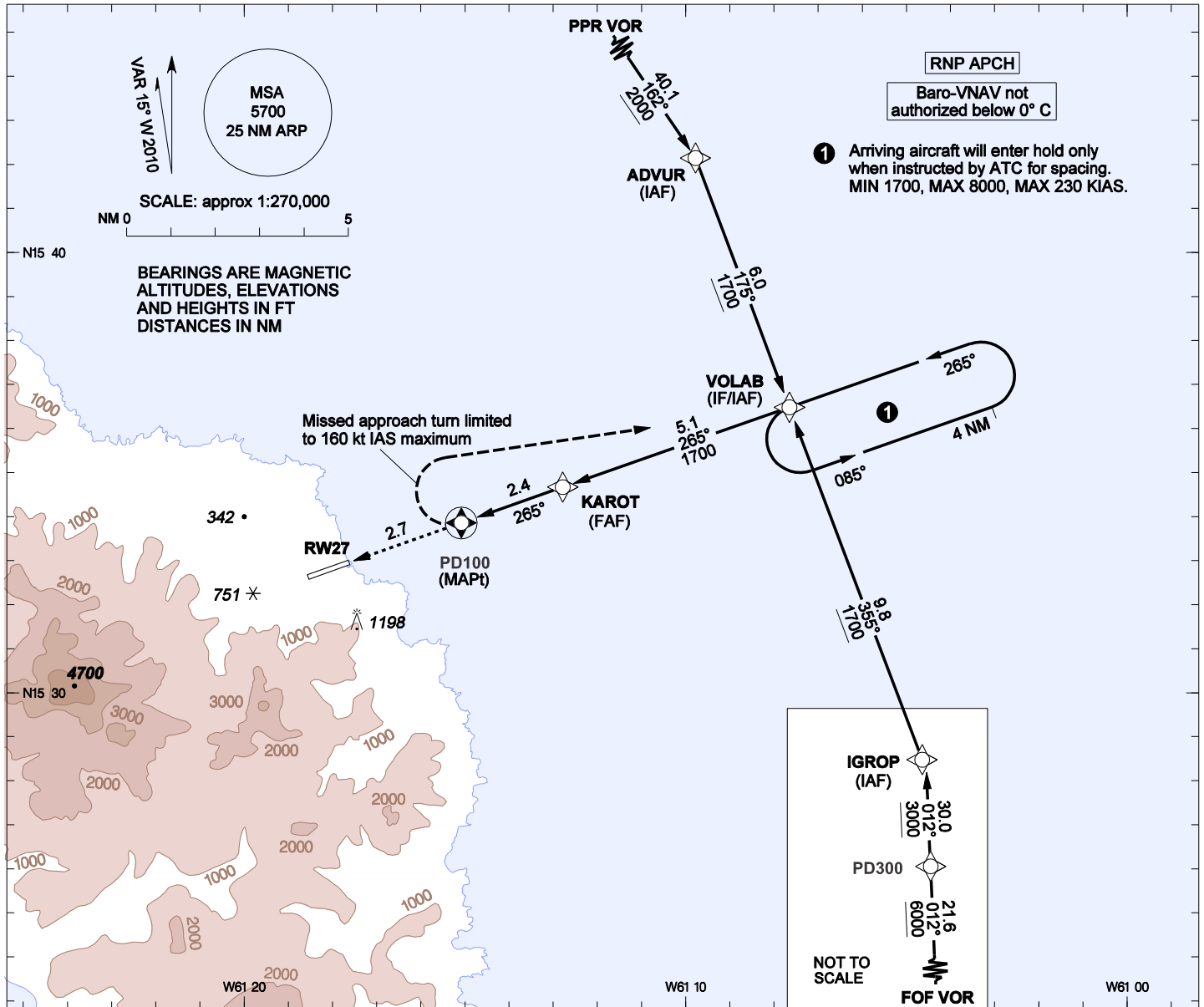

MISSED APPROACH: Climbing right turn to 1700 direct VOLAB and hold, or as directed by ATC. Missed approach turn limited to 160 kt IAS maximum.

TRANSITION LEVEL	BY ATC
TRANSITION ALTITUDE	9000

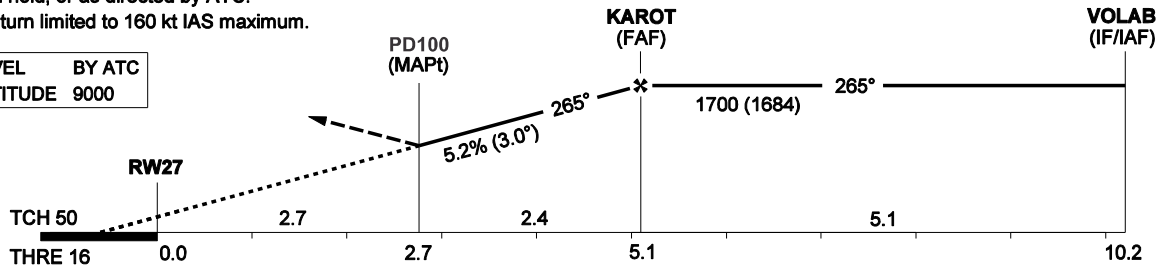

OCA (OCH)	A	B	C	D	GROUNDSPEED - DESCENT RATE					
					KNOTS	70	90	100	120	140
LNAV			940 (924)							
CIRCLING (north side and in daylight ONLY*)			1600' (1584) see EXCEPTION**		FT/MIN	372	478	531	637	743

*Landing Rwy 09 at night is prohibited. While circling north of the runway on left down-wind Rwy 09, visual contact with the runway will be obscured by a ridge-line, from the point of passing abeam the threshold Rwy 09 until completing the turn from base to final, which is normally made over a recognizable field of coconut trees. Minimum visibility to circle: 2 NM. Visual descent point (VDP) is distance before threshold where LNAV OCA meets 3° final slope.

**CIRCLING EXCEPTION: If the turn to base or final will be completed between 2 nm and 3 nm from THR 09, then the circling minimum altitude is 2000' and the minimum visibility is 3 nm.

TABULAR DESCRIPTION

RNAV (GNSS) Y RWY 27											
Serial Number	Path Descriptor	Waypoint identifier	Fly-over	Course °M (°T)	Magnetic Variation	Distance (NM)	Turn Direction	Altitude (ft.)	Speed Limit (kt.)	VPA°/TCH ft.	Navigation Specification
01	IF	PPR VOR	-	-	+15.0	-	-	-	-	-	RNP APCH
02	TF	ADVUR	-	162 (146.99)	+15.0	40.1	R	+2000	-	-	RNP APCH
03	TF	VOLAB	-	175 (159.97)	+15.0	6.0	R	+1700	-	-	RNP APCH
01	IF	FOF VOR	-	-	+15.0	-	-	-	-	-	RNP APCH
02	TF	PD300	-	012 (357.00)	+15.0	21.6	-	+6000	-	-	RNP APCH
03	TF	IGROP	-	012 (357.00)	+15.0	30.0	L	+3000	-	-	RNP APCH
04	TF	VOLAB	-	355 (340.00)	+15.0	9.8	L	+1700	-	-	RNP APCH
01	IF	VOLAB	-	-	+15.0	-	-	1700	-	-	RNP APCH
02	TF	KAROT	-	265 (249.98)	+15.0	5.1	-	1700	-	-	RNP APCH
03	TF	PD100	Y	265 (249.96)	+15.0	2.4	R	-	-	3.0/50	RNP APCH
04	DF	VOLAB	-	-	+15.0	-	-	1700	160*	-	RNP APCH

*Missed approach turn limited to 160 kt IAS maximum.

WAYPOINT LIST

RNAV (GNSS) Y RWY 27	
Waypoint Identifier	Coordinates
ADVUR	N15 42 08.55 W061 09 46.55
FOF VOR	N14 35 26.69 W061 01 22.11
IGROP	N15 27 13.06 W061 04 09.98
KAROT	N15 34 43.53 W061 12 37.56
PD100	N15 33 54.11 W061 14 57.31
PD300	N14 57 07.92 W061 02 32.35
PPR VOR	N16 15 54.70 W061 32 24.50
RW27	N15 32 57.42 W061 17 37.52
VOLAB	N15 36 29.06 W061 07 38.85

ATTACHMENT D

**INSTRUMENT
APPROACH
CHART - ICAO**

AERODROME ELEV 96 FT
OCH RELATED TO THRE
OTHER HEIGHTS RELATED TO AD ELEV

DOUGLAS CHARLES TWR 118.900
LE RAIZET APP 121.300 (N)
LE LAMENTIN APP 121.000 (S)

**ROSEAU, DOMINICA
DOUGLAS CHARLES APT (TDPD)
RNAV (GNSS) Z RWY 27**

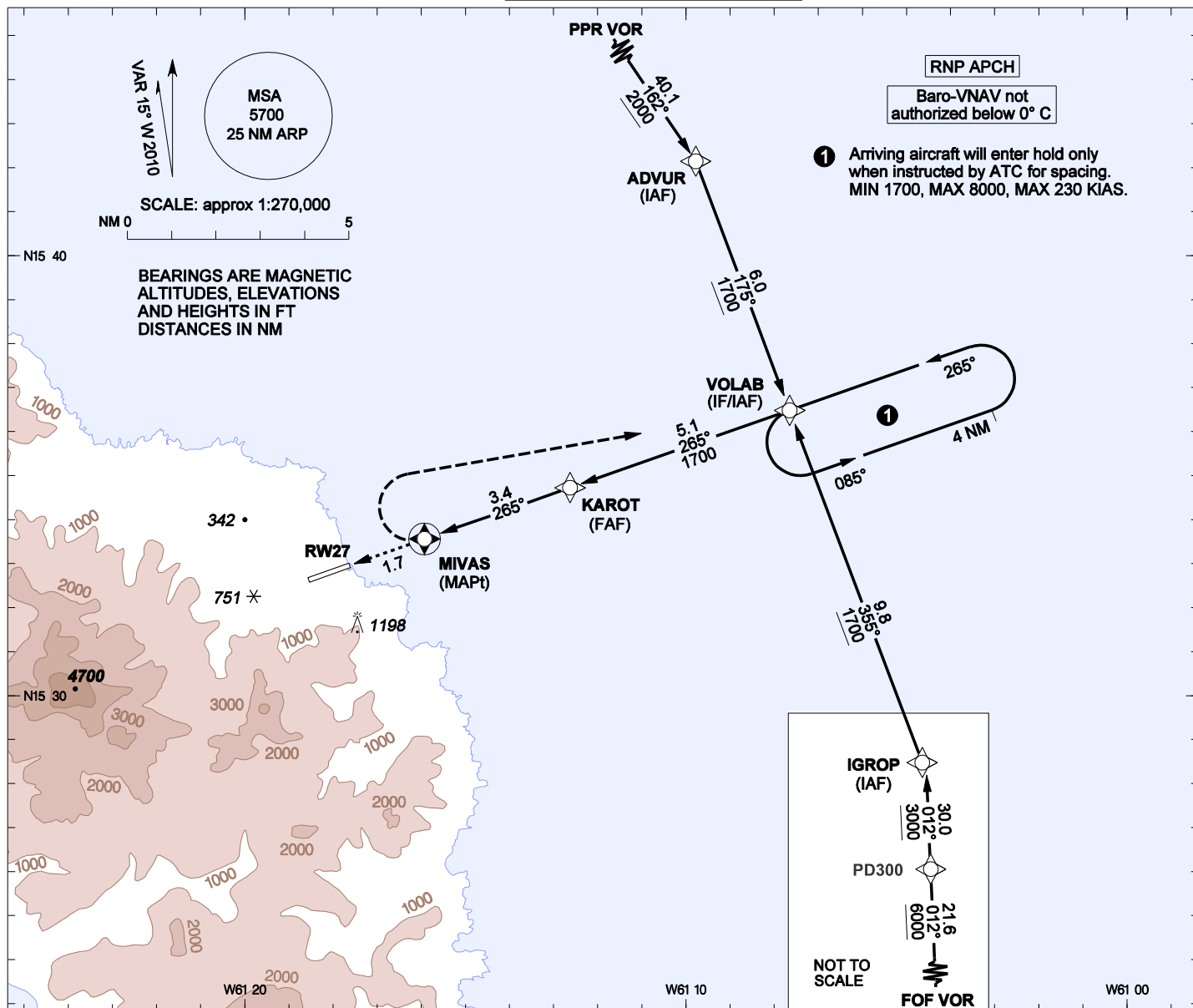

MISSED APPROACH: Climbing right turn to 1700 direct VOLAB and hold, or as directed by ATC.

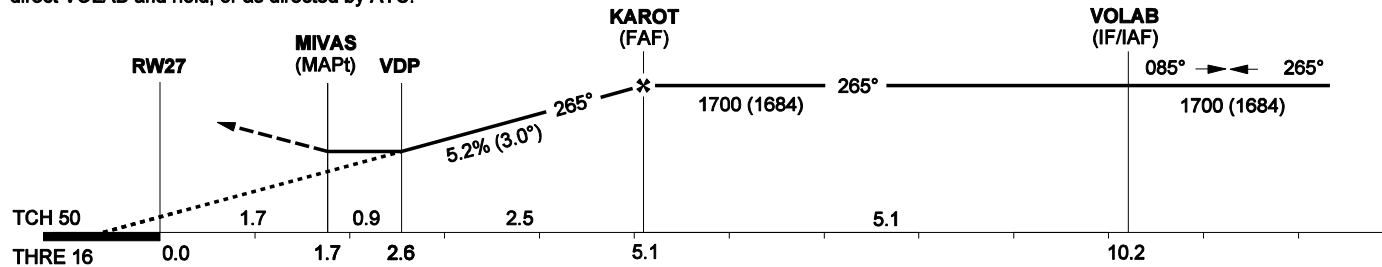

OCA (OCH)	A	B	C	D	GROUNDSPEED - DESCENT RATE					
					KNOTS	70	90	100	120	140
LNAV	900 (884)	900 (884)								
CIRCLING (north side and in daylight ONLY*)	1200 (1184)**	1600 (1584)**								
					FT/MIN	372	478	531	637	743

*Landing Rwy 09 at night is prohibited. While circling north of the runway on left down-wind Rwy 09, visual contact with the runway will be obscured by a ridge-line, from the point of passing abeam the threshold Rwy 09 until completing the turn from base to final, which is normally made over a recognizable field of coconut trees. Minimum visibility to circle: 2 NM. Visual descent point (VDP) is distance before threshold where LNAV OCA meets 3° final slope.

**CIRCLING EXCEPTION: If the turn to base or final will be completed between 2 nm and 3 nm from THR 09, then the circling minimum altitude is 2000' and the minimum visibility is 3 nm.

TABULAR DESCRIPTION

RNAV (GNSS) Z RWY 27											
Serial Number	Path Descriptor	Waypoint identifier	Fly-over	Course °M (°T)	Magnetic Variation	Distance (NM)	Turn Direction	Altitude (ft.)	Speed Limit (kt.)	VPA°/TCH ft.	Navigation Specification
01	IF	PPR VOR	-	-	+15.0	-	-	-	-	-	RNP APCH
02	TF	ADVUR	-	162 (146.99)	+15.0	40.1	R	+2000	-	-	RNP APCH
03	TF	VOLAB	-	175 (159.97)	+15.0	6.0	R	+1700	-	-	RNP APCH
01	IF	FOF VOR	-	-	+15.0	-	-	-	-	-	RNP APCH
02	TF	PD300	-	012 (357.00)	+15.0	21.6	-	+6000	-	-	RNP APCH
03	TF	IGROP	-	012 (357.00)	+15.0	30.0	L	+3000	-	-	RNP APCH
04	TF	VOLAB	-	355 (340.00)	+15.0	9.8	L	+1700	-	-	RNP APCH
01	IF	VOLAB	-	-	+15.0	-	-	1700	-	-	RNP APCH
02	TF	KAROT	-	265 (249.98)	+15.0	5.1	-	1700	-	-	RNP APCH
03	TF	MIVAS	Y	265 (249.96)	+15.0	3.4	-	-	-	3.0/50	RNP APCH
04	DF	VOLAB	-	-	+15.0	R	-	1700	-	-	RNP APCH

WAYPOINT LIST

RNAV (GNSS) Z RWY 27	
Waypoint Identifier	Coordinates
ADVUR	N15 42 08.55 W061 09 46.55
FOF VOR	N14 35 26.69 W061 01 22.11
IGROP	N15 27 13.06 W061 04 09.98
KAROT	N15 34 43.53 W061 12 37.56
MIVAS	N15 33 33.57 W061 15 55.38
PD300	N14 57 07.92 W061 02 32.35
PPR VOR	N16 15 54.70 W061 32 24.50
RW27	N15 32 57.42 W061 17 37.52
VOLAB	N15 36 29.06 W061 07 38.85

ATTACHMENT E

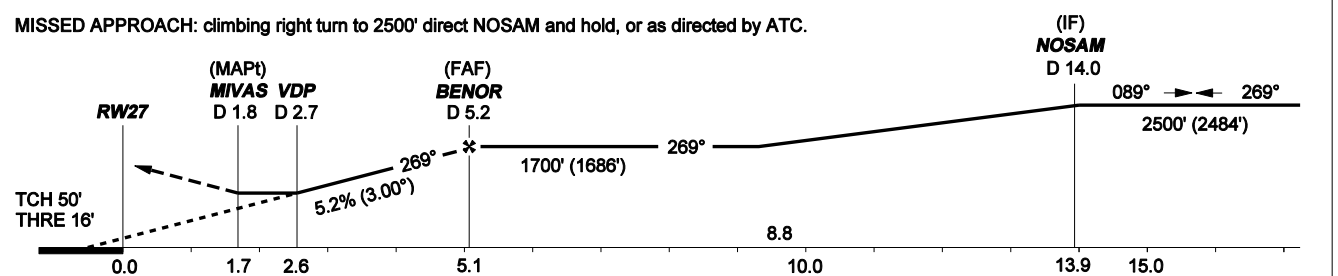
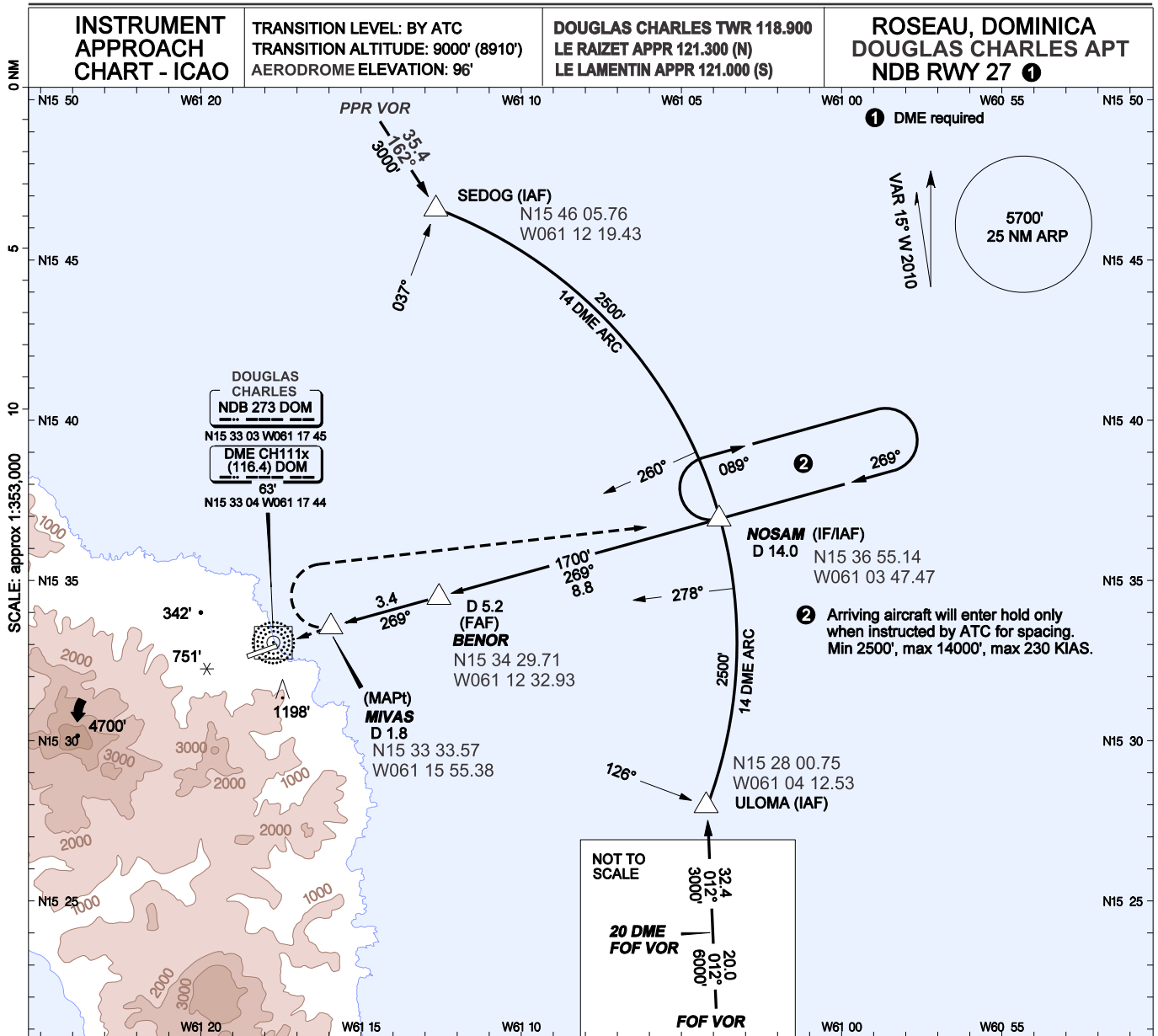

OCA(H)	A	B	C	D	GROUNDSPEED - DESCENT RATE					
					KNOTS	70	90	100	120	140
STRAIGHT-IN	900' (884')	900' (884')			FT/MIN	372	478	531	637	743
CIRCLING (north side and in daylight ONLY*)	1200' (1184')	1600' (1584')								
DME DOM	5.2	4.0	3.0	2.7						
ALT (HGT) 3° APCH	1700' (1684')	1308' (1292')	989' (973')	900' (884')						

*Landing Rwy 09 at night is prohibited. While circling north of the runway on left down-wind RWY 09, visual contact with the runway will be obscured by a ridge-line, from the point of passing abeam the threshold Rwy 09 until completing the turn from base to final, which is normally made over a recognizable field of coconut trees. Minimum visibility to circle: 2 nautical miles. Visual descent point (VDP) is distance before threshold where straight-in OCA meets 3° final slope. Bearings are magnetic, altitudes and elevation in feet, heights are relative to AD elevation, distance in NM.

Intentionally left blank



PIARCO INTERNATIONAL NOTAM OFFICE

**AIRAC
AIP
SUPPLEMENT**

Tele: 1 868 669-4128
1 868 668-8222 ext 2510
FAX: 1 868 669 1716
AFTN: TTPPYNYX
Email:aimpublication@caa.gov.tt

TRINIDAD & TOBAGO
CIVIL AVIATION AUTHORITY,
P.O. BOX 2163, NATIONAL MAIL CENTRE,
PIARCO
REPUBLIC OF TRINIDAD AND TOBAGO

**02/25
22 JAN 25**

AD

02. CANEFIELD INTERNATIONAL AIRPORT (TDCF)

**VERTICAL LIMITS OF THE AIR TRAFFIC SERVICES AIRSPACE AND AIRSPACE CLASSIFICATION
AMENDED**

Effective: 250220 to PERM

The Air Traffic Services Airspace and Classification along with other aerodrome information at the Canefield International Airport, have been amended.

Please see Attachment A for changes to Aerodrome and Enroute data.

END

Intentionally left blank

ATTACHMENT A

In this attachment, only the data that have been changed are available for the respective subsections of the AD and ENR pages for TDCF. All other information remains unchanged.

Please amend the relevant pages with the data below:

TDCF AD 2.2 AERODROME GEOGRAPHICAL AND ADMINISTRATIVE DATA

5	AD Administration, address, telephone, telefax, telex, AFS	Dominica Air and Sea Port Authority (DASPA) Head Office, Woodbridge Bay, Roseau, Dominica W.I. TEL: 1 767 255 9116 1 767 235 2419 E-MAIL: ceo@daspa.dm TELEX: - AFS: TDCFYAYX
6	Types of traffic permitted (IFR/VFR)	VFR

TDCF 2.3 OPERATIONAL HOURS

1	AD Administration	1200 -2100 MON, 1200 – 2000 TUES – FRI
6	MET Briefing Office	1200 -2100 MON, 1200 – 2000 TUES – FRI

TDCPF AD 2:4 HANDLING SERVICE AND FACILITIES

2	Fuel/Oil types	NIL
---	----------------	-----

TDCF AD 2.5 PASSENGER FACILITIES

2	Restaurants	NIL
---	-------------	-----

TDCF AD 2.11 METEOROLOGICAL INFORMATION PROVIDED

2	Hours of service MET Office outside hours	1200 -2100 MON, 1200 – 2000 TUES – FRI
---	--	---

ATTACHMENT A

TDCF AD 2.14 APPROACH AND RUNWAY LIGHTING

	THR LGT Colour WBAR	RWY edge LGT LEN, spacing colour INTST	RWY End LGT colour WBAR	Remarks
	3	7	8	10
01	NIL	NIL	NIL	NIL
19		NIL		

TDCF AD 2.15 OTHER LIGHTING, SECONDARY POWER SUPPLY

3	TWY edge and centre line lighting	NIL
4	Secondary power supply/switch-over time	NIL

TDCF AD 2.17 ATS AIRSPACE

2	Vertical limits	SFC / 3000 FT AAL
3	Airspace classification	D

TDCF AD 2.18 ATS COMMUNICATION FACILITIES

	Hours of Operation
	6
TWR	1200 -2100 MON, 1200 – 2000 TUES – FRI

ATTACHMENT A

TDCF AD 2.19 RADIO NAVIGATION AND LANDING AIDS

Type of aid, CAT of ILS/MLS	ID	Frequency	Hours of operation	Position of transmitting antenna coordinates	Elevation of DME transmitting antenna	Service volume radius from the GBAS reference point	Remarks
1	2	3	4	5	6	7	8
NIL	NIL	NIL	NIL	NIL	NIL	NIL	NIL

TDCF AD 2.22 FLIGHT PROCEDURES

1. Procedures for VFR flights

1.1 General

- 1.1.2 Landing and take-off are prohibited if the average crosswinds exceed 15 knots. Runway will reopen when the average wind speed drops below 15 knots, calculated over a thirty (30) minute period.
- 1.1.3 Landing and take-off are prohibited with winds gusts above 20 knots. Runway will reopen when the average wind speed drops below 20 knots, calculated over a thirty (30) minute period.

2. Canefield Airport Standard Operating Procedures

2.1 The Canefield Airport will be closed when the following conditions exist:

2.1.1 VFR conditions (ICAO ANNEX 2, 4.1)

- i) The ceiling is less than 450m (1500 ft) and /or
- ii) The ground visibility is less than 5 km.

2.1.2 Wind

- i) Frequent wind gust above 15 knots- that is more than one (1) gust within a 15-minute period.
- ii) Average constant crosswind above 15 knots.
- iii) Average tailwind above 15 knots.

ATTACHMENT A

2.1.3 Wind shear and turbulence

- i) Any pilot report of moderate to severe wind shear or turbulence.

2.1.4 Other

- a) Field may be closed:
 - i) if the conditions are better than stated in 2.1.1, 2.1.2 and 2.1.3
 - ii) if turbulence and wind shear also exist.
- b) Field is to be reopened when:
 - i) Conditions in 2.1.1 (i) and (ii) no longer exist.
 - ii) 15 minutes have elapsed if conditions listed in 2.1.1, 2.1.2 and 2.1.3 no longer exist.

The following are changes to the ENR 2.2 page for the change in Vertical Limits and Airspace Classification:

ENR 2.2.2 AERODROME TRAFFIC ZONES (ATZ)

Name Lateral limits Vertical limits Class of airspace	Units providing service	Call sign Languages Area and conditions of use Hours of service	Frequency/ Purpose	Remarks
1	2	3	4	5
<p>CANEFIELD AERODROME TRAFFIC ZONE (ATZ) (Dominica)</p> <p>Circular area centered on 152015N/ 0612332W (ARP) within a 2NM radius.</p> <p><u>3000FT</u> AAL SFC</p> <p>CLASS of Airspace: D</p>				

Intentionally left blank

**PIARCO INTERNATIONAL NOTAM OFFICE****AIP
SUPPLEMENT**

Tele: 1 868 669-4128
1 868 668-8222 ext 2510
FAX: 1 868 669 1716
AFTN: TTPPYNYX
Email:aimpublication@caa.gov.tt

TRINIDAD & TOBAGO
CIVIL AVIATION AUTHORITY,
P.O. BOX 2163, NATIONAL MAIL CENTRE,
PIARCO
REPUBLIC OF TRINIDAD AND TOBAGO

29/24
16 DEC 24

AD**29. C.J. LLOYD INTERNATIONAL AIRPORT (TQPF)****Amendments to the Aerodrome data for the C.J. Lloyd International Airport****Effective: 241216 to PERM**

The information in the following attachments have been updated:

- Attachment A - Update to data pages;
- Attachment B - Update to Aerodrome Chart - ICAO.

END

Intentionally left blank

ATTACHMENT A

TQPF AD 2.8 APRONS, TAXIWAYS AND CHECK LOCATIONS DATA

1	Apron surface and strength	Apron Main: Type of surface: Asphalt Strength: PCR 189/F/B/X/T
		Apron Main Northeast: Type of surface: Concrete Strength: PCR 564/R/B/W/T
		Apron West: Type of surface: Concrete Strength: PCR 263/R/D/Y/T
		Cargo Apron: Type of Surface: Concrete Strength: PCR 610/R/B/W/T
2	Taxiway width, surface and strength	TWY A Width: 18.3M Type of surface: Concrete Strength: PCR 263/R/D/Y/T
		TWY B Width: 17.3M Type of surface: Asphalt Strength: PCR 260/F/B/X/T
		TWY C Width: 18M Type of surface: Asphalt Strength: PCR 252/F/B/X/T
		TWY D Width: 10.5M Type of surface: Concrete Strength: PCR 485/R/B/W/T
		TWY E Width: 15.75M Type of surface: Concrete Strength: PCR 485/R/B/W/T
3	ACL location and elevation	Location: Apron Elevation: 30.87M/101.25FT
4	VOR Checkpoints	NIL
5	INS Checkpoints	NIL
6	Remarks	NIL

ATTACHMENT A

TQPF AD 2.12 RUNWAY PHYSICAL CHARACTERISTICS

Designators RWY NR	TRUE & MAG BRG	Dimensions of RWY (M)	Strength (PCR) and surface of RWY and SWY	THR Coordinates/ RWY End Coordinates THR GUND	THR elevation and highest elevation of TDZ of precision APP RWY	Slope of RWY-SWY
1	2	3	4	5	6	7
11	091° GEO 105° MAG	1664 x 30	PCR 550/F/B/W/T Grooved Asphalt	181217.53N 0630337.08W	THR 36.04M (118.24FT)	Nil
29	271° GEO 285° MAG	1664 x 30	PCR 550/F/B/W/T Grooved Asphalt	181217.03N 0630250.67W	THR 23.65M (77.59FT)	Nil

SWY Dimensions (M)	CWY Dimensions (M)	Strip Dimensions (M)	RESA Dimensions	Location/ description of arresting system	OFZ	Remarks
8	9	10	11	12	13	14
Nil	Nil	Nil	90 x 90	Nil	Nil	Thresholds marked as displaced. Length includes 60M strip and 90M RESA. Grooved Asphalt. Beginning of paved surface 181217.59N 0630342.20W Elev 37.72M (123.75FT)
Nil	Nil	Nil	90 x 90	Nil	Nil	Thresholds marked as displaced. Length includes 60M strip and 90M RESA. Grooved Asphalt. Beginning of paved surface 181216.97N 0630245.55W Elev 21.98M (72.11FT)

ATTACHMENT B

**AERODROME
CHART - ICAO**

ARP 181217.28N 0630313.87W

AD ELEVATION 124FT

**CLAYTON J LLOYD The Valley, Anguilla
TQPF**

GUND (Geoid Undulation) =
The height of the Geoid (MSL) above the Reference Ellipsoid (WGS84) at the stated position

BEARINGS ARE MAGNETIC
ELEVATIONS AND HEIGHTS ARE IN FEET

ELEVATIONS IN FEET AMSL	192
HEIGHTS IN FEET ABOVE AD	(68)

RUNWAY/TAXIWAY/APRON PHYSICAL CHARACTERISTICS		
APRON/RWY	SURFACE	BEARING STRENGTH
RWY 11/29	Groved Asphalt	PCR 550/F/B/W/T
TAXIWAY A	Concrete	PCR 263/R/D/Y/T
TAXIWAY B	Asphalt	PCR 260/F/B/X/T
TAXIWAY C	Asphalt	PCR 252/F/B/X/T
TAXIWAY D	Concrete	PCR 485/R/B/W/T
TAXIWAY E	Concrete	PCR 485/R/B/W/T
MAIN APRON	Asphalt	PCR 189/F/B/X/T
MAIN APRON (NORTH EAST)	Concrete	PCR 564/R/B/W/T
Apron at TWY A	Concrete	PCR 263/R/D/Y/T
CARGO APRON	Concrete	PCR 610/R/B/W/T
HANGAR APRON	Asphalt	PCR 189/F/B/X/T

DECLARED DISTANCES (metres)				
	TORA	TODA	ASDA	LDA
RWY 11	1514	1514	1514	1364
RWY 29	1514	1514	1514	1364

TORA for both runways starts 150m before the Thresholds

MAIN APRON			
STAND	COORDINATE		Elevation AMSL(ft)
1	181221.98N	0630311.01W	102.0
2	181221.98N	0630309.57W	101.7
3	181222.01N	0630308.71W	101.4
4	181222.01N	0630307.89W	101.5
5	181222.01N	0630307.06W	101.8
6	181222.01N	0630306.24W	101.5
7	181222.00N	0630305.45W	101.5
8	181222.01N	0630304.62W	101.6
9	181220.72N	0630305.30W	99.8
10	181220.73N	0630307.61W	100.3

VAR 14.2°W - 2018
N
Annual Rate of Change 0.02°W

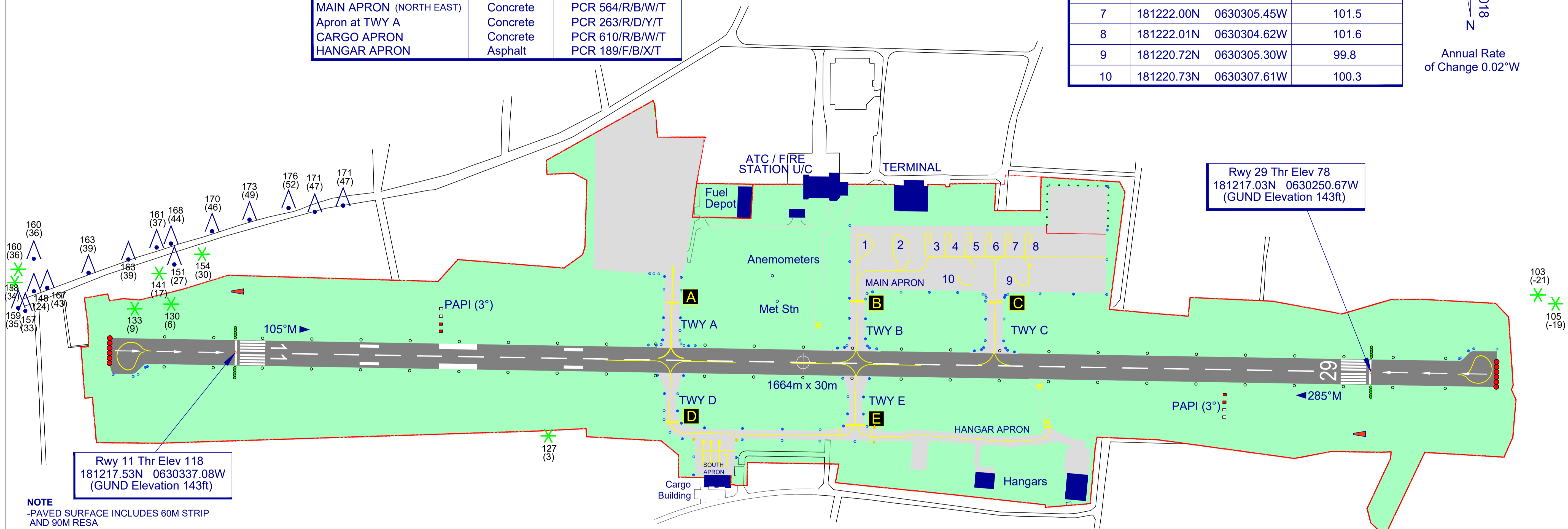

Rwy 11 Thr Elev 118
181217.53N 0630337.08W
(GUND Elevation 143ft)

Rwy 29 Thr Elev 78
181217.03N 0630250.67W
(GUND Elevation 143ft)

NOTE
-PAVED SURFACE INCLUDES 60M STRIP AND 90M RESA
-THRESHOLDS ARE MARKED AS DISPLACED 150M FROM THE BEGINNING OF PAVED SURFACE

RESTRICTIONS
-CONTROLLED AIRSPACE
-VISIBILITY EXEMPTED BY DAY
-INSTRUMENT RESTRICTED BY NIGHT

CAUTION
-NUMEROUS POLES AND ANTENNAS IN VICINITY OF AERODROME

SOUTH APRON		
STAND	COORDINATE	Elevation AMSL(ft)
1	181213.67N 0630317.00W	105.0
2	181213.67N 0630317.93W	104.2
3	181213.43N 0630317.26W	105.1

COM		
TWR	118.5MHz	C.J. Lloyd Tower
LIGHTING		
THR 11/29	Green Wing bars	
RWY 11/29	Hi White Edge 60m spacing, End lights red	
RWY 11	PAPI-L (3°)	
RWY 29	PAPI-L (3°)	
TWY A	Blue edge	
TWY B & C	Blue edge	
TWY D	Blue edge	
TWY E	Blue edge	

LEGEND	
AERODROME REFERENCE POINT (ARP)	⊕
BUILDING	■
WINDSLEEVE	↗
TREE / BUSH	✱
TELEPOLE, AERIAL, POST, ETC	⋈
RWY END LIGHTS	●●●●
RWY THR WING BAR LIGHTS	●●●●
PAPI LIGHTS	□□□□
SRA DELINEATORS	⊖

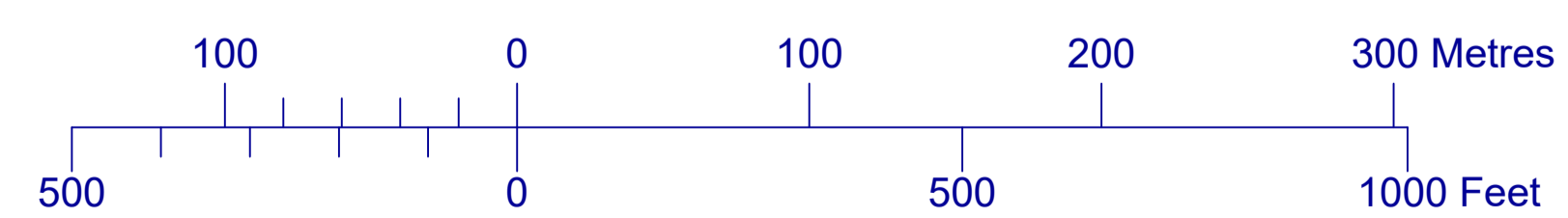

Intentionally left blank

**PIARCO INTERNATIONAL NOTAM OFFICE****AIP
SUPPLEMENT**

Tele: 1 868 669-4128
1 868 668-8222 ext 2510
FAX: 1 868 669 1716
AFTN: TTPPYNYX
Email:aimpublication@caa.gov.tt

TRINIDAD & TOBAGO
CIVIL AVIATION AUTHORITY,
P.O. BOX 2163, NATIONAL MAIL CENTRE,
PIARCO
REPUBLIC OF TRINIDAD AND TOBAGO

27/24
28 NOV 24

AD**27. V.C. BIRD INTERNATIONAL AIRPORT (TAPA)****Establishment of Area Chart - ICAO V.C. Bird TMA****Effective: 241128 to PERM**

A new area chart has been established for V.C. Bird TMA.

Please see Attachment A for the new chart.

END

Intentionally left blank

ATTACHMENT A

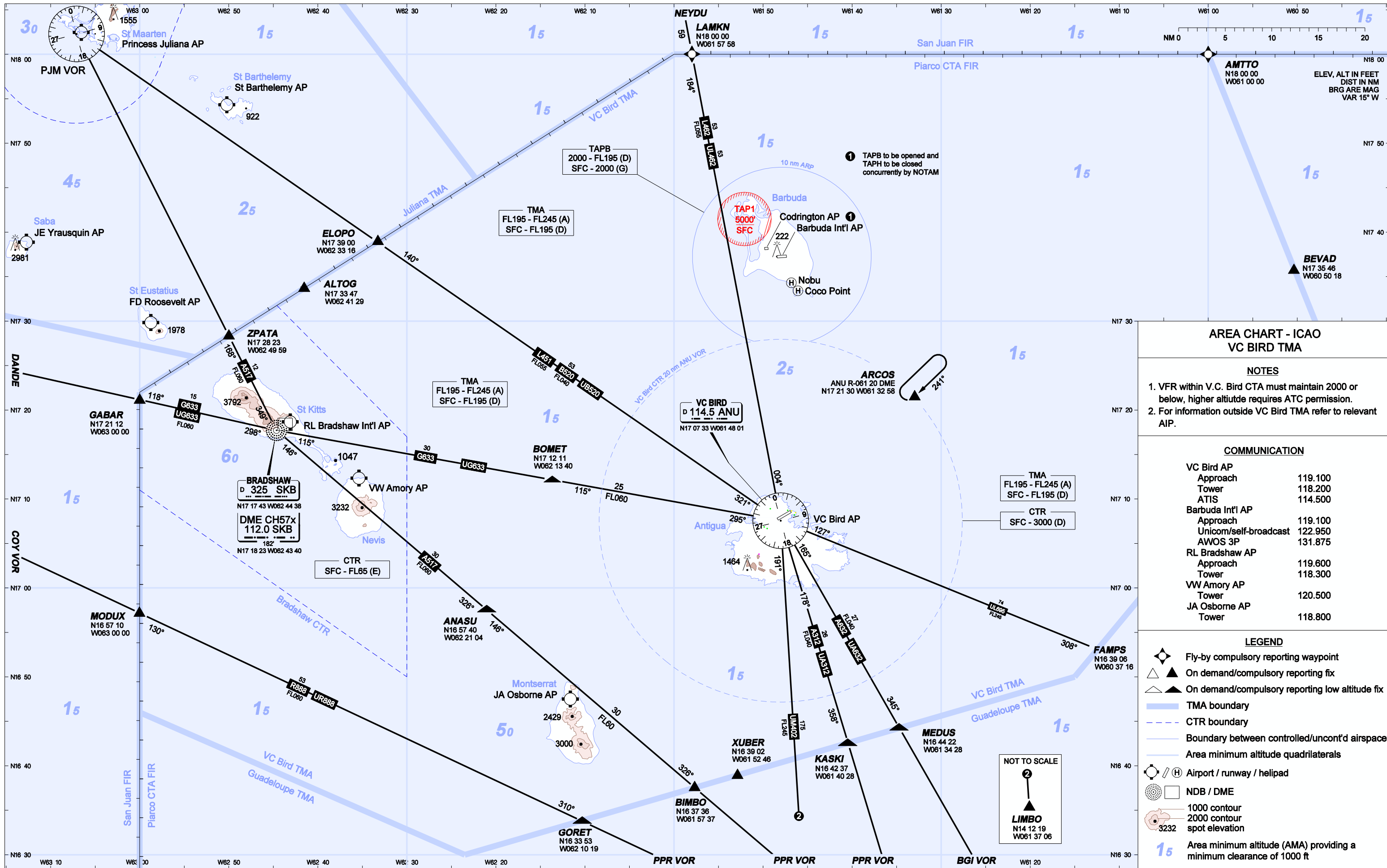

AREA CHART - ICAO
VC BIRD TMA

NOTES

1. VFR within V.C. Bird CTA must maintain 2000 or below, higher altitude requires ATC permission.
2. For information outside VC Bird TMA refer to relevant AIP.

COMMUNICATION

VC Bird AP	
Approach	119.100
Tower	118.200
ATIS	114.500
Barbuda Int'l AP	
Approach	119.100
Unicom/self-broadcast	122.950
AWOS 3P	131.875
RL Bradshaw AP	
Approach	119.600
Tower	118.300
VW Amory AP	
Tower	120.500
JA Osborne AP	
Tower	118.800

LEGEND

- Fly-by compulsory reporting waypoint
- On demand/compulsory reporting fix
- On demand/compulsory reporting low altitude fix
- TMA boundary
- CTR boundary
- Boundary between controlled/uncont'd airspace
- Area minimum altitude quadrilaterals
- Airport / runway / helipad
- NDB / DME
- 1000 contour
- 2000 contour
- spot elevation
- Area minimum altitude (AMA) providing a minimum clearance of 1000 ft

NOT TO SCALE

2

LIMBO
N14 12 19
W061 37 06

Intentionally left blank

**PIARCO INTERNATIONAL NOTAM OFFICE****AIP
SUPPLEMENT**

Tele: 1 868 669-4128
1 868 668-8222 ext 2510
FAX: 1 868 669 1716
AFTN: TTPPYNYX
Email:aimpublication@caa.gov.tt

TRINIDAD & TOBAGO
CIVIL AVIATION AUTHORITY,
P.O. BOX 2163, NATIONAL MAIL CENTRE,
PIARCO
REPUBLIC OF TRINIDAD AND TOBAGO

26/24
28 NOV 24

AD**26. PIARCO INTERNATIONAL AIRPORT (TTPP) AND A.N.R. ROBINSON INTERNATIONAL AIRPORT (TTCP)****TTPP RNAV (GNSS) RWY 10, TTPP RNAV (GNSS) RWY 28, TTCP RNAV (GNSS) RWY 11 and TTCP RNAV (GNSS) RWY 29 Charts Amended****Effective: 241128 to PERM**

The following changes have been incorporated into the attached Piarco RNAV (GNSS) RWY 10 chart, Piarco RNAV (GNSS) RWY 28 chart, A.N.R. Robinson RNAV (GNSS) RWY 11 chart and A.N.R. Robinson RNAV (GNSS) RWY 29 chart, and relevant verso pages:

- Chart identification from RNAV (GNSS) to RNP;
- PBN requirement box in profile view;
- Removal of asterisk (*) from TTPP verso tables for waypoints LEXOR, TALUS, BOSAT, DANON and removal of asterisk note, "**previous waypoint identifier with updated coordinates*";
- Removal of asterisk (*) from TTCP verso tables for waypoints SASIM, NOTEL, DEBOP, VODAN and removal of asterisk note, "**previous waypoint identifier with updated coordinates*".

Please see attachments A, B, C and D for updated charts for TTPP and TTCP.

Please amend the Eastern Caribbean AIP pages AD 2.10-1-33, AD 2.10-1-34, AD 2.10-1-35, AD 2.10-1-36, AD 2.10-2-31, AD 2.10-2-32, AD 2.10-2-33, AD 2.10-2-34

END

Intentionally left blank

ATTACHMENT A

**INSTRUMENT
APPROACH
CHART - ICAO**

AERODROME ELEV 58 ft
HEIGHTS RELATED TO
THR RWY 10 - ELEV 30 ft

PIARCO APP 119,000, 119,550
PIARCO TWR 118,100
PIARCO ATIS 126,700

**PORT OF SPAIN/
PIARCO Intl (TTPP)**
RNP RWY 10

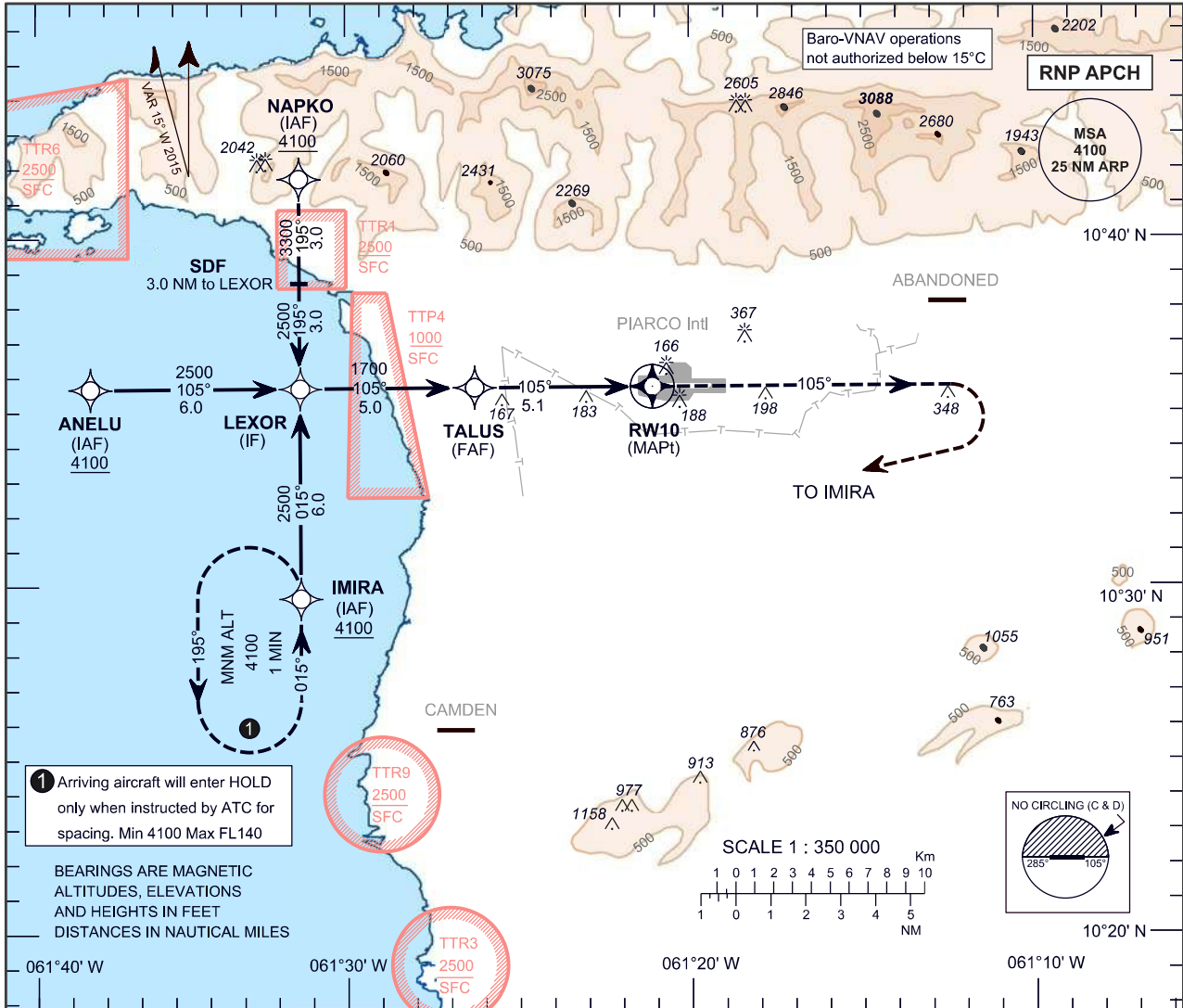

NM to NEXT WPT	RW10	2	3	4	5
ALTITUDE		720	1040	1360	1680

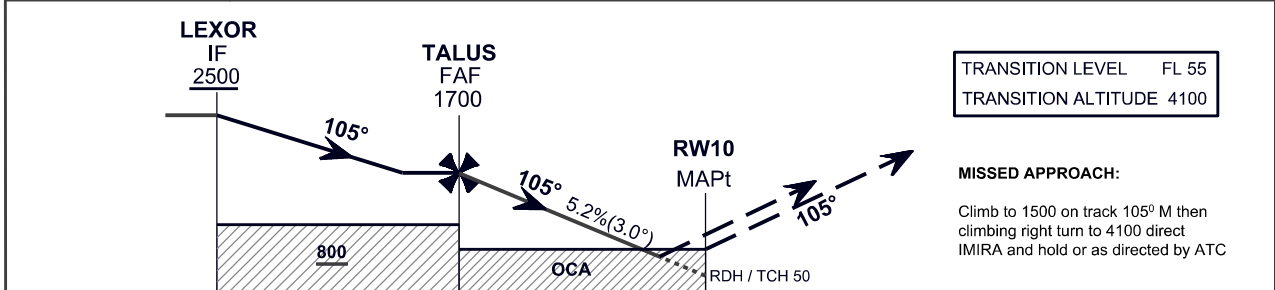

NM to/from THR RWY 10	10	5.0	5.1	0
				THR ELEV 30

OCA (OCH)	A	B	C	D
LNAV		430 (400)		
LNAV/VNAV		350 (320)		
*CIRCLING	670	670	710	830
*CIRCLING NOT AUTHORIZED NORTH OF AD (CAT C & D)				

Ground Speed	kt	70	90	100	120	140	160
Rate of descent FAF-MAPt 3.0°(5.2%)	f/min	372	478	531	637	743	849

TABULAR DESCRIPTION

RNP RWY 10											
Serial Number	Path Descriptor	Waypoint Identifier	Fly Over	Course °M (°T)	Magnetic Variation	Distance (NM)	Turn Direction	Altitude (ft.)	Speed Limit (kt.)	VPA/TCH	Navigation Specification
10	IF	ANELU	-	-	-	-	-	+4100	-	-	RNP APCH
20	TF	LEXOR	-	105 (89.8)	-	6.0	-	+2500	-	-	RNP APCH
10	IF	IMIRA	-	-	-	-	-	+4100	-	-	RNP APCH
20	TF	LEXOR	-	015 (359.8)	-	6.0	-	+2500	-	-	RNP APCH
10	IF	NAPKO	-	-	-	-	-	+4100	-	-	RNP APCH
20	TF	LEXOR	-	195 (179.8)	-	6.0	-	+2500	-	-	RNP APCH
10	IF	LEXOR	-	-	-	-	-	+2500	-	-	RNP APCH
20	TF	TALUS	-	105 (89.8)	-	5.0	-	@1700	-	-	RNP APCH
30	TF	RW10	Y	105 (89.8)	-	5.1	-	@80	-	-3.0/50	RNP APCH
40	CA	-	-	105 (89.8)	+15.0	-	-	+1500	-	-	RNP APCH
50	DF	IMIRA	-	-	-	-	R	+4100	-	-	RNP APCH
60	HM	IMIRA	-	015 (359.8)	-	-	L	+4100	-	-	RNP APCH

WAYPOINT LIST

RNP RWY 10	
Waypoint Identifier	Coordinates
ANELU	10°35'39.77"N 061°37'26.83"W
IMIRA	10°29'39.49"N 061°31'20.17"W
NAPKO	10°41'42.79"N 061°31'22.42"W
LEXOR	10°35'41.14"N 061°31'21.29"W
TALUS	10°35'42.19"N 061°26'16.67"W
RW10	10°35'43.18"N 061°21'06.69"W
(Stepdown Fix) - 3.0 NM to LEXOR	10° 38' 41.97" N 061° 31' 21.85"W

ATTACHMENT B

**INSTRUMENT
APPROACH
CHART - ICAO**

AERODROME ELEV 58 ft
HEIGHTS RELATED TO
THR RWY 28 - ELEV 58 ft

PIARCO APP 119.000, 119.550
PIARCO TWR 118.100
PIARCO ATIS 126.700

**PORT OF SPAIN/
PIARCO Intl (TTPP)**
RNP RWY 28

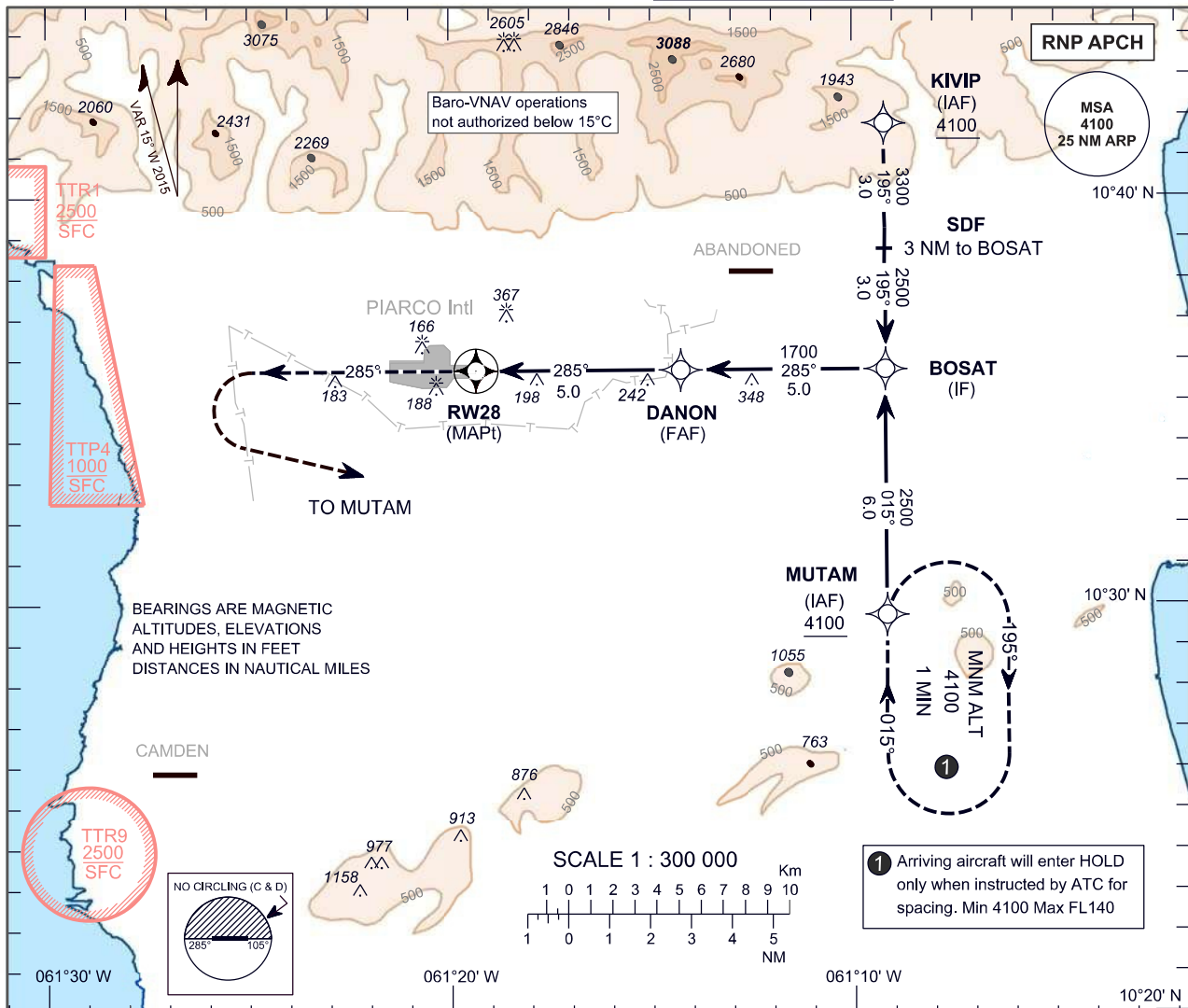

NM to NEXT WPT	RW28	2	3	4	5
ALTITUDE		750	1070	1390	1700

TRANSITION LEVEL FL 55
TRANSITION ALTITUDE 4100

MISSED APPROACH:
Climb to 1000 on track 285° M then climbing left turn to 4100 direct MUTAM and hold or as directed by ATC

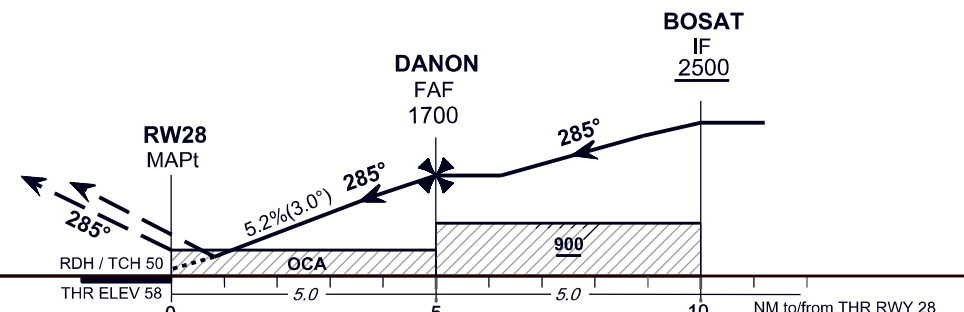

OCA (OCH)	A	B	C	D
LNAV	490 (432)			
LNAV/VNAV	360 (302)			
*CIRCLING	670	670	710	830
*CIRCLING NOT AUTHORIZED NORTH OF AD (CAT C & D)				

Ground Speed	kt	70	90	100	120	140	160
Rate of descent FAF-MAPt 3.0°(5.2%)	ft/min	372	478	531	637	743	849

TABULAR DESCRIPTION

RNP RWY 28											
Serial Number	Path Descriptor	Waypoint Identifier	Fly Over	Course °M (°T)	Magnetic Variation	Distance (NM)	Turn Direction	Altitude (ft)	Speed Limit (kt)	VPA/TCH	Navigation Specification
10	IF	KIVIP	-	-	-	-	-	+4100	-	-	RNP APCH
20	TF	BOSAT	-	195 (179.8)	-	6.0	-	+2500	-	-	RNP APCH
10	IF	MUTAM	-	-	-	-	-	+4100	-	-	RNP APCH
20	TF	BOSAT	-	015 (359.8)	-	6.0	-	+2500	-	-	RNP APCH
10	IF	BOSAT	-	-	-	-	-	+2500	-	-	RNP APCH
20	TF	DANON	-	285 (269.8)	-	5.0	-	@1700	-	-	RNP APCH
30	TF	RW28	Y	285 (089.8)	-	5.0	-	@108	-	-3.0/50	RNP APCH
40	CA	-	-	285 (269.8)	+15.0	-	-	+1000	-	-	RNP APCH
50	DF	MUTAM	-	-	-	-	L	+4100	-	-	RNP APCH
60	HM	MUTAM	-	015 (359.8)	-	-	R	+4100	-	-	RNP APCH

WAYPOINT LIST

RNP RWY 28	
Waypoint Identifier	Coordinates
KIVIP	10°41'46.78"N 061°09'13.25"W
MUTAM	10°29'43.48"N 061°09'11.07"W
BOSAT	10°35'45.13"N 061°09'12.16"W
DANON	10°35'44.35"N 061°14'16.78"W
RW28	10°35'43.50"N 061°19'21.40"W
(Stepdown Fix) - 3.0 nm to BOSAT	10°38'45.96"N 061°09'12.71"W

ATTACHMENT C

**INSTRUMENT
APPROACH
CHART - ICAO**

AERODROME ELEV 38 ft
HEIGHTS RELATED TO
DISP THR RWY 11- ELEV 29 ft

PIARCO APP 119.000, 119.550
ROBINSON TWR 118.400
ROBINSON ATIS 132.200

**SCARBOROUGH/
A.N.R. ROBINSON Intl (TTCP)**
RNP RWY 11

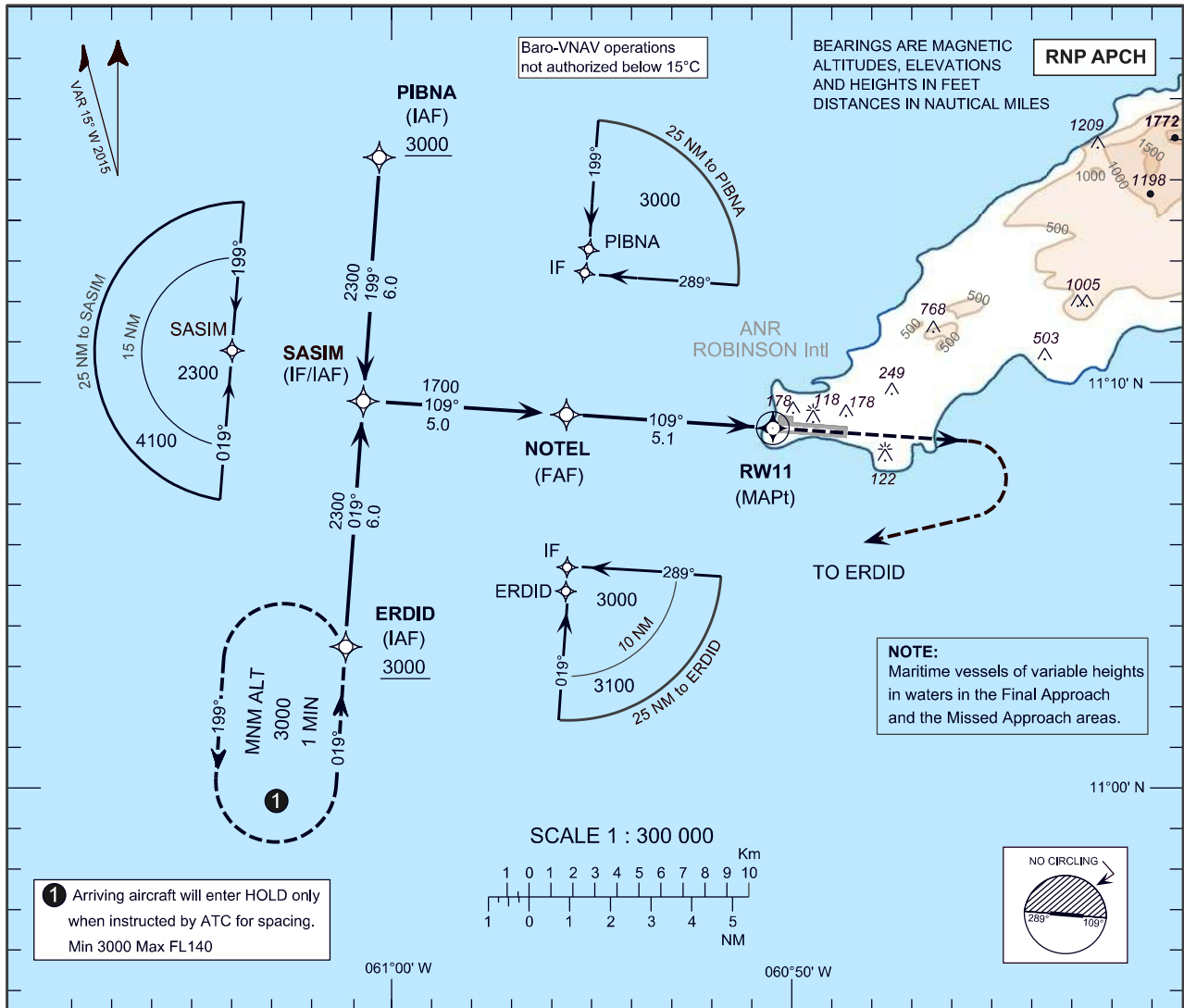

NM to NEXT WPT	RW11	2	3	4	5
ALTITUDE		720	1040	1360	1680

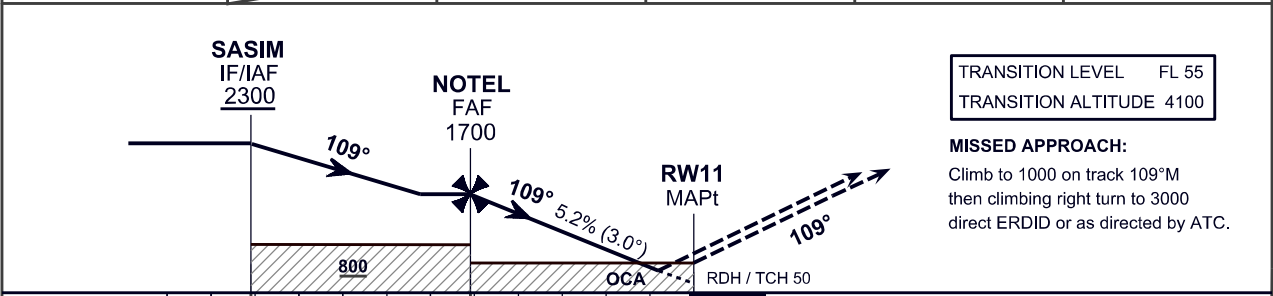

NM to/from DISP THR RWY 11	10	5.0	5	5.1	0	THR ELEV 29
----------------------------	----	-----	---	-----	---	-------------

OCA (OCH)	A	B	C	D
LNAV		500 (471)		
LNAV/VNAV		340 (311)		
*CIRCLING	550	550	650	730
*CIRCLING NOT AUTHORIZED NORTH OF AD (ALL CATs)				

Ground Speed	kt	70	90	100	120	140	160
Rate of descent FAF-MAPt 3.0°(5.2%)	ft/min	372	478	531	637	743	849

TABULAR DESCRIPTION

RNP RWY 11											
Serial Number	Path Descriptor	Waypoint Identifier	Fly Over	Course °M (°T)	Magnetic Variation	Distance (NM)	Turn Direction	Altitude (ft)	Speed Limit (kt)	VPA/TCH	Navigation Specification
10	IF	ERDID	-	-	-	-	-	+3000	-	-	RNP APCH
20	TF	SASIM	-	019 (004.2)	-	6.0	-	+2300	-	-	RNP APCH
10	IF	PIBNA	-	-	-	-	-	+3000	-	-	RNP APCH
20	TF	SASIM	-	199 (184.2)	-	6.0	-	+2300	-	-	RNP APCH
10	IF	SASIM	-	-	-	-	-	+2300	-	-	RNP APCH
20	TF	NOTEL	-	109 (094.2)	-	5.0	-	@1700	-	-	RNP APCH
30	TF	RW11	Y	109 (094.2)	-	5.1	-	@79	-	-3.0/50	RNP APCH
40	CA	-	-	109 (094.2)	+15.0	-	-	+1000	-	-	RNP APCH
50	DF	ERDID	-	-	-	-	R	+3000	-	-	RNP APCH
60	HM	ERDID	-	019 (004.2)	-	-	L	+3000	-	-	RNP APCH

WAYPOINT LIST

RNP RWY 11	
Waypoint Identifier	Coordinates
ERDID	11°03'45.02"N 061°01'12.49"W
PIBNA	11°15'46.36"N 061°00'18.93"W
SASIM	11°09'45.69"N 061°00'45.72"W
NOTEL	11°09'23.78"N 060°55'41.33"W
RW11	11°09'01.39"N 060°50'31.40"W

ATTACHMENT D

**INSTRUMENT
APPROACH
CHART - ICAO**

AERODROME ELEV 38 ft
HEIGHTS RELATED TO
THR RWY 29 - ELEV 20 ft

PIARCO APP 119.000, 119.550
ROBINSON TWR 118.400
ROBINSON ATIS 132.200

**SCARBOROUGH/
A.N.R. ROBINSON Intl (TTCP)**
RNP RWY 29

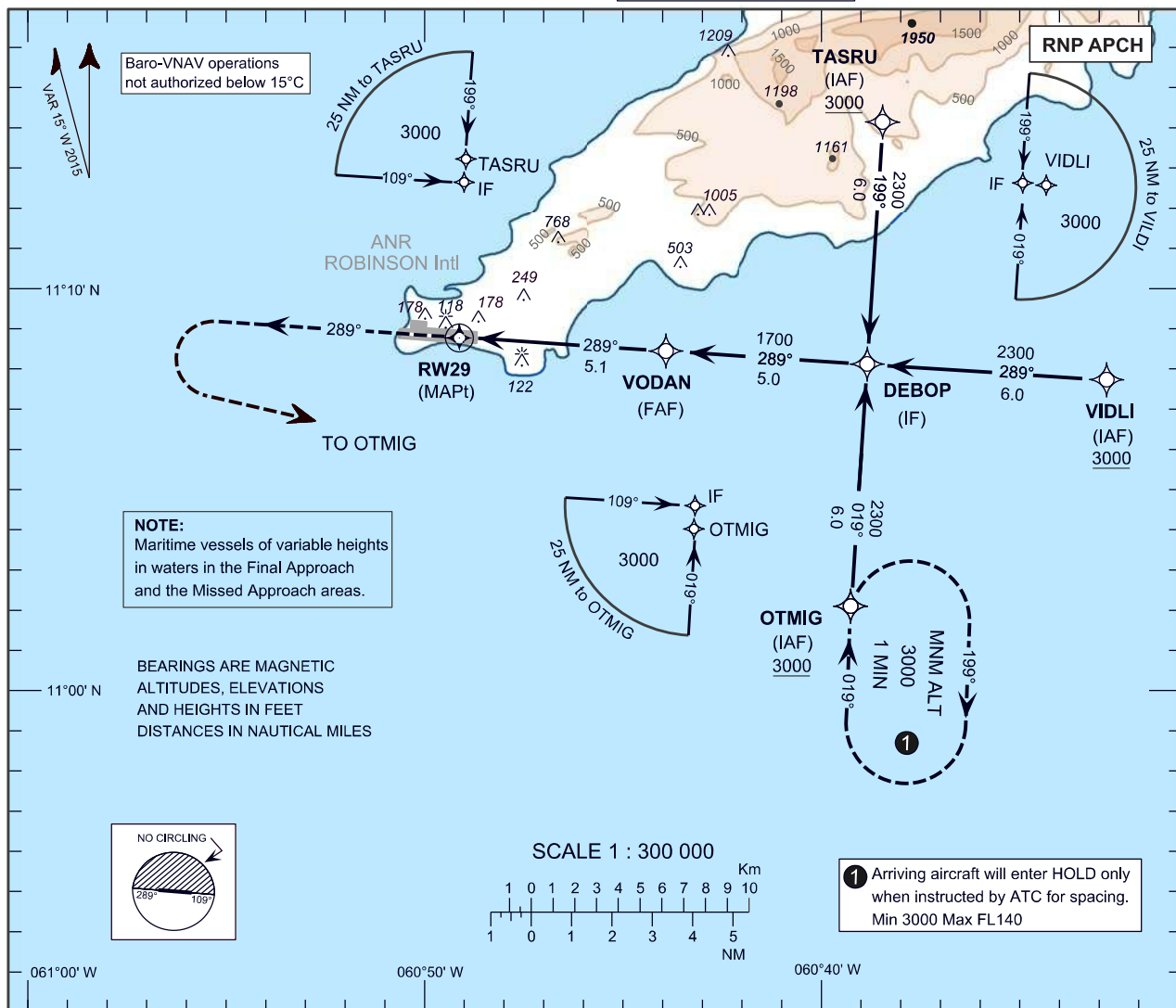

NM to NEXT WPT	RW29	2	3	4	5
ALTITUDE		710	1030	1350	1670

TRANSITION LEVEL FL 55
TRANSITION ALTITUDE 4100

MISSED APPROACH:
Climb to 1000 on track 289°M then climbing left turn to 3000 direct OTMIG or as directed by ATC.

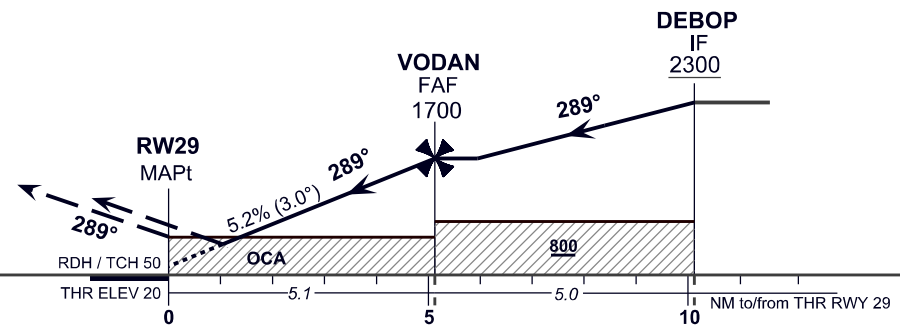

OCA (OCH)	A	B	C	D
LNAV	500 (480)			
LNAV/VNAV	340 (320)			
*CIRCLING	550	550	650	730
*CIRCLING NOT AUTHORIZED NORTH OF AD (ALL CATs)				

Ground Speed	kt	70	90	100	120	140	160
Rate of descent FAF-MAPt 3.0°(5.2%)	ft/min	372	478	531	637	743	849

TABULAR DESCRIPTION

RNP RWY 29											
Serial Number	Path Descriptor	Waypoint Identifier	Fly Over	Course °M (°T)	Magnetic Variation	Distance (NM)	Turn Direction	Altitude (ft.)	Speed Limit (kt.)	VPA/TCH	Navigation Specification
10	IF	VIDLI	-	-		-	-	+3000	-	-	RNP APCH
20	TF	DEBOP	-	289 (274.2)		6.0	-	+2300	-	-	RNP APCH
10	IF	TASRU	-	-		-	-	+3000	-	-	RNP APCH
20	TF	DEBOP	-	199 (184.2)		6.0	-	+2300	-	-	RNP APCH
10	IF	OTMIG	-	-		-	-	+3000	-	-	RNP APCH
20	TF	DEBOP	-	019 (004.2)		6.0	-	+2300	-	-	RNP APCH
10	IF	DEBOP	-	-		-	-	+2300	-	-	RNP APCH
20	TF	VODAN	-	289 (274.2)		5.0	-	@1700	-	-	RNP APCH
30	TF	RW29	Y	289 (274.2)		5.1	-	@70	-	-3.0/50	RNP APCH
40	CA	-	-	289 (274.2)	+15.0	-	-	+1000	-	-	RNP APCH
50	DF	OTMIG	-	-		-	L	+3000	-	-	RNP APCH
60	HM	OTMIG	-	019 (004.2)		-	R	+3000	-	-	RNP APCH

WAYPOINT LIST

RNP RWY 29	
Waypoint Identifier	Coordinates
VIDLI	11°07'44.00"N 060°32'49.77"W
OTMIG	11°02'10.07"N 060°39'21.77"W
TASRU	11°14'11.41"N 060°38'28.16"W
DEBOP	11°08'10.74"N 060°38'54.97"W
VODAN	11°08'32.93"N 060°43'59.32"W
RW29	11°08'55.56"N 060°49'10.92"W

**PIARCO INTERNATIONAL NOTAM OFFICE****AIP
SUPPLEMENT**

Tele: 1 868 669-4128
1 868 668-8222 ext 2510
FAX: 1 868 669 1716
AFTN: TTPPYNYX
Email:aispublications@caa.gov.tt

TRINIDAD & TOBAGO
CIVIL AVIATION AUTHORITY,
P.O. BOX 2163, NATIONAL MAIL CENTRE,
PIARCO
REPUBLIC OF TRINIDAD AND TOBAGO

24/24
08 OCT 24

ENR**24. PIARCO (TTPP)****Model Aircraft Display****Effective: 241008 to 261011**

Model aircraft display at Frederick Settlement within a radius of 1KM centred on 103538N0612337W from SFC to 400FT AGL.

Pilots flying the area are asked to exercise caution.

AIP SUP 24/24 replaces AIP SUP 10/22.

END

Intentionally left blank

**PIARCO INTERNATIONAL NOTAM OFFICE****AIRAC
AIP
SUPPLEMENT**

Tele: 1 868 669-4128
1 868 668-8222 ext 2510
FAX: 1 868 669 1716
AFTN: TTPPYNYX
Email: aispublications@caa.gov.tt

TRINIDAD & TOBAGO
CIVIL AVIATION AUTHORITY,
P.O. BOX 2163, NATIONAL MAIL CENTRE,
PIARCO
REPUBLIC OF TRINIDAD AND TOBAGO

19/24
30 AUG 24

AD**19. DOUGLAS CHARLES AIRPORT (TDPD)****Extension of RWY 09/27 at the Douglas Charles Airport****Effective: 241003 to PERM**

RWY 09/27 at the Douglas Charles Airport has been extended towards the western end of the runway.

As a result of this extension, the information in the following attachments have been updated:

- Attachment A - Update to data and chart pages.
- Attachment B – Update to Aerodrome Chart – ICAO.
- Attachment C – Update to Aerodrome Obstacle Chart – ICAO Type A - Operating Limitations RWY 09/27.

Please amend the following Eastern Caribbean AIP pages: AD 2.4-2-1, AD 2.4-2-5, AD 2.4-2-13, AD 2.4-2-15, AD 2.4-2-17, AD 2.4-2-18, AD 2.4-2-21, AD 2.4-2-23, AD 2.4-2-25.

END

Intentionally left blank

ATTACHMENT A

In this attachment, only the data that have been changed are available for the respective sub-sections of the AD pages for TDPD. All other information remains unchanged.

Please amend the relevant pages with the data below:

TDPD AD 2.2 AERODROME GEOGRAPHICAL AND ADMINISTRATIVE DATA

3	Elevation/Reference Temperature	29.3M (96FT) / 31°C
4	MAG VAR/annual change	15.2°W (2024)

TDPD AD 2.12 RUNWAY PHYSICAL CHARACTERISTICS

Designations RWY NR	Dimensions of RWY (M)	THR coordinates/RWY End Coordinates	Strip Dimension (M)	Remarks
1	3	5	10	12
09	1936 x 45	153235.82N 0611838.56W	1928 x 150	RWY Surface Grooved. THR RWY 09 displaced 405M RESA 90x90
27	1936 x 45		1928 x 150	RWY Surface Grooved. RESA 90x90

TDPD AD 2.13 DECLARED DISTANCES

RWY designator	TORA (M)	TODA (M)	ASDA (M)	LDA (M)	Remarks
1	2	3	4	5	6
09	1936	2726	1936	1403	RWY 09 THR displaced 405M
27				1808	

TDPD AD2.14 APPROACH AND RUNWAY LIGHTING

RWY designator	RWY edge LGT LEN, spacing, color, INTST
1	7
09	1936M White LIH
27	1936M White LIH

ATTACHMENT A

The following updated charts have been provided:

- Aerodrome/Heliport Chart – ICAO page AD 2.4-2-13
- Aerodrome Obstacle Chart – ICAO Type A RWY -09/27 page AD 2.4-2-15.

The Aerodrome elevation to be updated to **96 FT** on the following pages:

- AD 2.4-2-17/18– TDPD KAROT ONE RNAV (GNSS) Departure
- AD 2.4-2-21 – RNAV (GNSS) Y RWY 27
- AD 2.4-2.23 – RNAV (GNSS) Z RWY 27
- AD 2.4-2-25 – NDB RWY 27

The MAG VAR to be updated to 15.2°W on the following page:

- AD 2.4-2-17/18– TDPD KAROT ONE RNAV (GNSS) Departure

ATTACHMENT B

AERODROME CHART - ICAO
ARP: N15 32 47.63
W061 18 05.19
AERODROME ELEV: 96
DOUGLAS CHARLES TOWER 118.900
LE RAIZET APPROACH 121.300 (NORTH)
LE LAMENTIN APPROACH 121.000 (SOUTH)
DIMENSIONS IN FEET / METERS
ELEVATIONS IN FEET
BEARINGS ARE MAGNETIC
DOUGLAS CHARLES APT (TDPD)
ROSEAU, DOMINICA

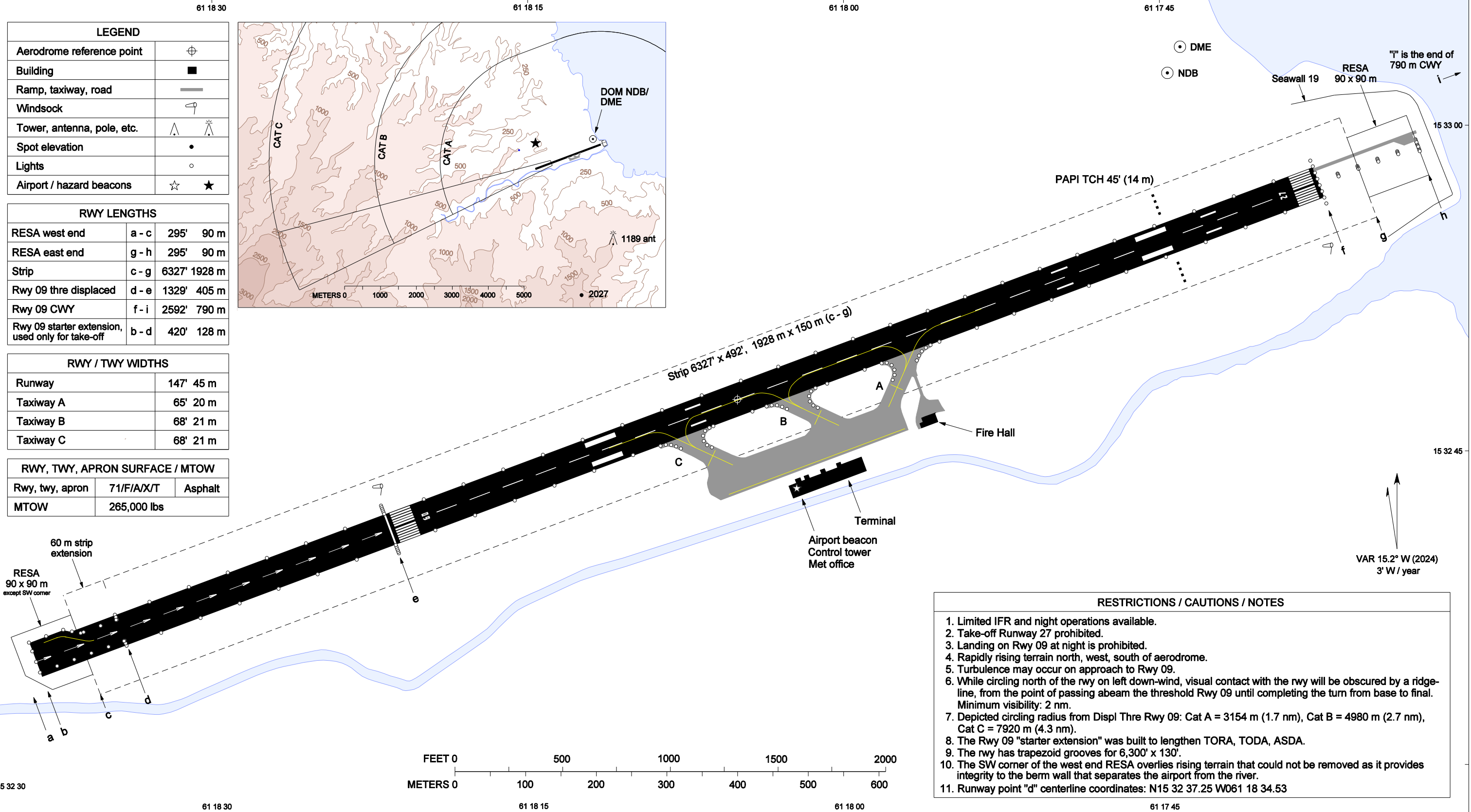

RWY	TORA	TODA	ASDA	LDA	START OF TORA/TODA/ASDA	POINT	ELEV	START OF LDA	POINT	ELEV	BEARING	LIGHTING
09	6352' 1936 m (b - f)	8944' 2726 m (b - i)	6352' 1936 m (b - f)	4602' 1403 m (e - f)	N15 32 35.82 W061 18 38.56	b	96' 29.3 m	N15 32 41.78 W061 18 21.74	e	71' 21.7 m	085°	Rwy thre identif, rwy thre, high intensity rwy edge lts (HIRL), rwy end
27	Prohibited	Prohibited	Prohibited	5933' 1808 m (f - d)				N15 32 57.42 W061 17 37.52	f	16' 4.9 m	265°	Approach, PAPI-L/R 3.00°, rwy thre identif, rwy thre, HIRL, rwy end

CHANGES: RWY extended to the West, Declared Distances updated, West End RESA updated, RWY and AD Elev adjusted, MAG VAR updated (2024).

Intentionally left blank

ATTACHMENT C

**DIMENSIONS IN METERS / FEET
ELEVATIONS IN METERS / FEET**

**AERODROME OBSTACLE CHART - ICAO
TYPE A - OPERATING LIMITATIONS RWY 09/27**

**DOUGLAS CHARLES AIRPORT (TDPD)
ROSEAU, DOMINICA**

MAGNETIC VARIATION 15° W - JUNE 2024

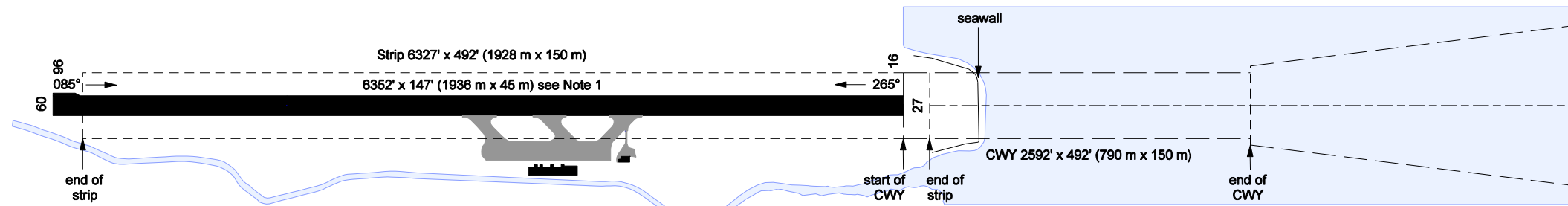
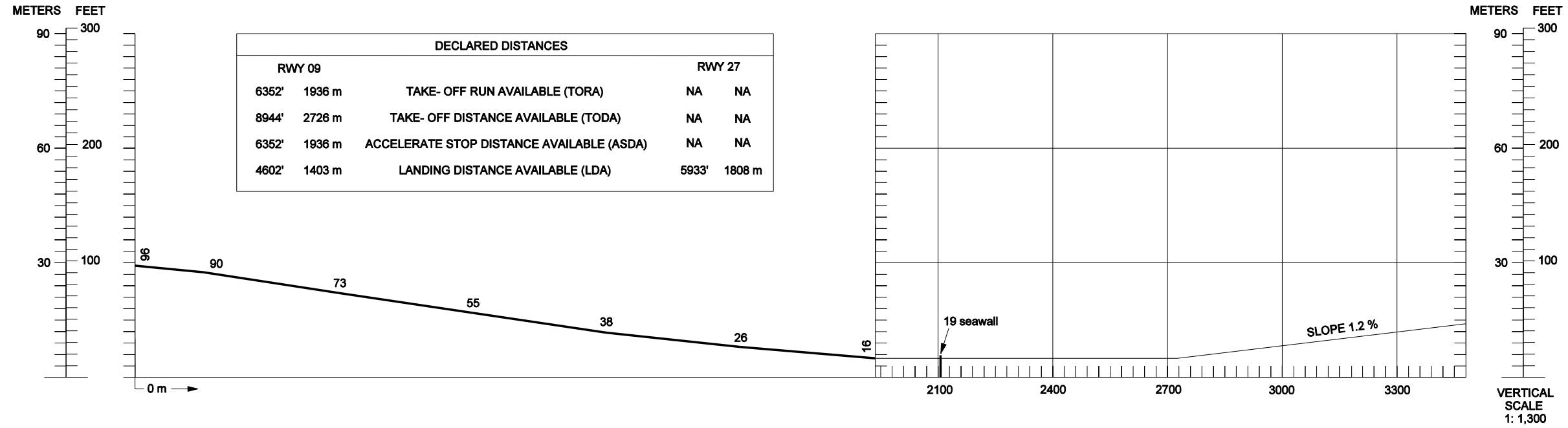

Note 1: Reflects the Rwy 09 TORA

LEGEND	PLANVIEW	PROFILE
IDENTIFICATION NUMBER	①	
POLE, TOWER, ANTENNA	△	INSIDE OUTSIDE
POLE, TOWER, ANTENNA LIGHTED	△*	①
BUILDING	■	①
TREE, BUSH	*x	

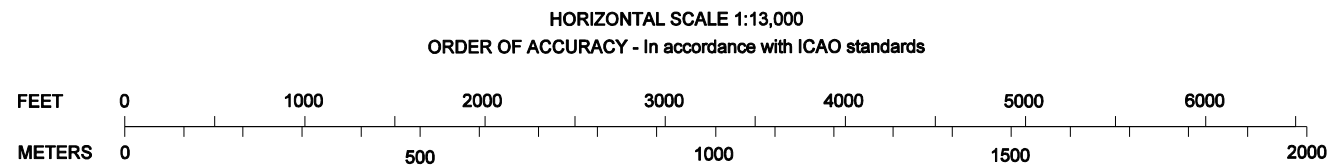

AMENDMENT RECORD		
No.	DATE	ENTERED BY
Original	AIRAC date	Chart provider

CHANGES: RWY extended to the West, Declared Distances updated, RWY and AD Elev adjusted, MAG VAR updated (2024).

Intentionally left blank



PIARCO INTERNATIONAL NOTAM OFFICE

AIRAC AIP SUPPLEMENT

Tele: 1 868 669-4128
1 868 668-8222 ext 2510
FAX: 1 868 669 1716
AFTN: TTPPYNYX
Email: aispublications@caa.gov.tt

TRINIDAD & TOBAGO
CIVIL AVIATION AUTHORITY,
P.O. BOX 2163, NATIONAL MAIL CENTRE,
PIARCO
REPUBLIC OF TRINIDAD AND TOBAGO

15/24
03 OCT 24

Publication date: 06th August 2024

ENR

15. PIARCO FIR (TTZP)

Establishment of Waypoint CAIRN on the Common Boundary between the Pointe-A-Pitre (Guadeloupe) Terminal Control Area (TMA) and the Piarco Flight Information Region (TTZP)

Effective: 241003 to PERM

1. Introduction

1.1 The following waypoint has been established on the northeastern boundary of the Pointe-A-Pitre (Guadeloupe) Terminal Control Area (TMA) and the Piarco FIR:

CAIRN 16 55 36N 060 34 57W.

This waypoint will facilitate aircraft exiting the Pointe-A-Pitre (Guadeloupe) Terminal Control Area (TMA) via waypoint CITRS (18 00 00N 059 00 00W) and east.

2. Procedures

2.1 Arriving Aircraft

2.1.1 Aircraft inbound to Le Raizet International Airport, Guadeloupe (TFFR) from waypoint BNJEE (18 00 00N 060 00 00W) shall plan a flight route to enter Guadeloupe TMA at waypoint BOSET.

2.2 Departing Aircraft

2.2.1 Aircraft departing the Le Raizet International Airport, Guadeloupe (TFFR) leaving the TTZP FIR at waypoint CITRS (18 00 00N 059 00 00W) or east, shall plan a flight route to exit Guadeloupe TMA at waypoint CAIRN.

Please amend the following pages of the Eastern Caribbean AIP: ENR 4.4-2, ENR 6.1-1, ENR 6.1-3, ENR 6.1-7 and ENR 6.1-9.

END

Intentionally left blank

Intentionally left blank

**PIARCO INTERNATIONAL NOTAM OFFICE****AIP
SUPPLEMENT**

Tele: 1 868 669-4128
1 868 668-8222 ext 2510
FAX: 1 868 669 1716
AFTN: TTPPYNYX
Email:aispublications@caa.gov.tt

TRINIDAD & TOBAGO
CIVIL AVIATION AUTHORITY,
P.O. BOX 2163, NATIONAL MAIL CENTRE,
PIARCO
REPUBLIC OF TRINIDAD AND TOBAGO

14/24
15 JUL 24

GEN**14. St. Vincent and the Grenadines****Airport Service Charge amended for Argyle International Airport (TVSA), J.F. Mitchell Airport (TVSB), Canouan Airport (TVSC) and Union Airport (TVSU)****Effective: 240715 to PERM**

The Airport Service Charge (Passenger Service) is now \$150.00 E.C. or \$55.00 USD.

Please amend the Eastern Caribbean AIP page GEN 4.1-19

END

Intentionally left blank